



Designed to Delight You



- Interior Bathware
- Outdoor Aqua Luxuries
- Hospitality Hotelware

LOOK BOOK 2022



Contents

| | |
|------------------------------------|-------|
| » Swimming Pool | 01-07 |
| » Spa Bath | 08-12 |
| » Sauna Bath | 13-16 |
| » Steam Bath | 17-18 |
| » Bath Cabin..... | 19 |
| » Multi System | 20 |
| » Bath Tub..... | 21-36 |
| » Whirlpool System / Jacuzzi..... | 37-38 |
| » Chiller Bath..... | 39 |
| » Sewage Pumps | 40 |
| » Pressure Pumps | 41 |
| » Water Treatment | 42 |
| » Decorative Water Fountains..... | 43-67 |
| » Hotel Hospitality Products | 68-84 |

We are all about

Hydro plus Industries is the perfect destination, from where all buyers can get number of products which help in making your life both enjoyable and stress free. Hydro plus Industries established in 2010 & Now it has established As a Pvt. Ltd. Company in 2018 . Hydro Plus Industries has repeatedly impressed the market and set industry standards with new solutions. As a result the company has evolved into one of the best known and most valuable brands in its core markets — within its own industry and beyond. Its dominant brand values of security, reliability, innovation and engineering skills are complemented by the brand promise “Beyond security”. Hydro Plus Industries Pvt. Ltd. drives its innovation leadership through constant innovation and product development. The central focus is always the benefit to customers. New products and upgrades are not only safe, reliable, and user-friendly but fit seamlessly into existing systems. To ensure customer requirements always remain at the centre of product development, Hydro Plus Industries Pvt. Ltd. coordinates its innovation management across the Group. Its structures and processes are optimized to identify and meet customer requirements.

The Hydro Plus Industries is one of the most acknowledged name in the specialized manufacturing Swimming pool & Accessories history in the market we have been successfully innovating and manufacturing new products that meet the need of the modern lifestyle, offering a supreme range of advanced quality products, which include- Swimming Pool, Bath Tub ,Spa Bath, Multisystem, Bath Cabin, Sauna Bath, Steam Bath ,Water Treatment Plant, Pressure Pump and Chiller Bath. Exclusive range of and Swimming pool that is manufactured and supply with acute sense of responsibility. All our Swimming Pools are being manufactured considering the international standards.

Our Aim

Our aim is to increase our overseas by provide customer, with excellent products at great prices, keep growing and to open new distribution points around India & Nepal and become the largest Independent cleaning supplier in Delhi.

Infrastructure

We are backed by the sophisticated infrastructure, well-equipped with modern tools and machinery, further; we take all the necessary measures in order to deliver the excellent range of products. Besides, we also have a spacious warehouse which helps us in safe and bulk storage of the products.

Quality

Our quality management system is well-defined and is made considering the ever-changing demands of the customers. We have recruited a separate team of quality auditors which keep a close watch on the entire production and distribution system.

Achievements:-

- * Supreme Court Guest House (CPWD) Delhi
- * HAL (Orissa)
- * Health Club (Rurki) Defence
- * Celebration Garden Delhi
- * Toshali Royal View
- * Sterling Holiday Resort
- * Brys Resort Nanital
- * Anukampa Group Rajasthan



Swimming Pool

Types of Pools

- 1 Fiber Glass Swimming Pool
- 2 Civil Swimming Pool
- 3 Fiber Panel Swimming Pool
- 4 S S Panel Swimming Pool



Fiber Glass Swimming Pool



Model No. - H.P. 10 | Size - 22' x 10' x 4'5", 18' x 10' x 4'5"



Model No. - H.P. 11 | Size - 20' x 8' x 4'5", 16' x 8' x 4'5"



Model No. - H.P. 12 | Size - 24' x 10' x 4'5"

These Swimming pools are made by fiber glass with gel coat system. Easy to install long lasting, smooth finish and also customized design. These pools are best for Residential purpose. Fiberglass pools are economically sensible, and because they are so easy to maintain, bring a lot of fun and family enjoyment to your summers, and a lot less worry about what has to be done.

Fiberglass is so smooth, dirt that settles to the bottom is slowly eased toward the main drains where it is easily removed, or just runs through the filter. These Pools are very close to "maintenance free" swimming pool.

Some of the other salient features also shown why fiberglass pools are so popular, and demand continues to rise.

- » Safe and aesthetic design
- » Inbuilt counter current system
- » Low Chemical Requirements
- » Lesser time required for Installation
- » Steps and sitting area can be made inside the pool
- » Anti slippery floor surface
- » In-built filtration system
- » In-built Jacuzzi and Air jet Systems
- » Algae won't stick to the walls

Civil Swimming Pool



Concrete pools are some of the highest quality swimming pools built. When constructed properly, these pools offer years of use before requiring much maintenance or repair. The most popular type of concrete pool construction today is done with either shotcrete or gunite, which are mixtures of concrete and sand that are sprayed onto a metal frame. Most of bigger and commercialized swimming pools are designed and constructed by this method. Filtration plant and draining system required a heavy plumbing work.

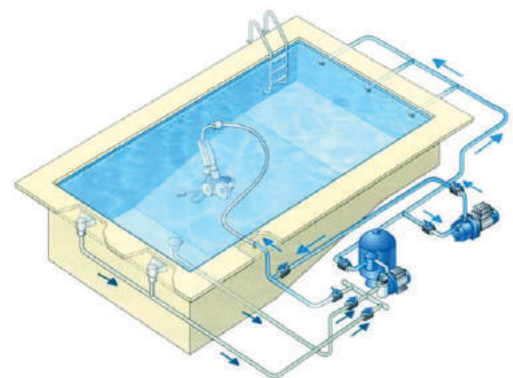

Fiber Panel Swimming Pool

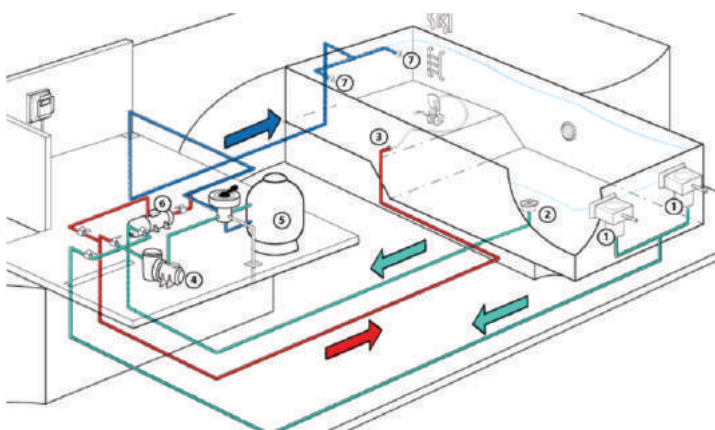

Fiber Panel Swimming Pool constructed by fiber panel supportive walls depending on the size and design of the swimming pool. In this kind of swimming pool we used liner inside the swimming pool. Fiber panel take support of concrete outside the swimming pool. Liner provides smooth finish, nice look and easy to install. Filtration plant installed outside the swimming pool a bit plumbing work required.

Swimming Pool accessories



Arc Hook Waterfall



Wall Brush



Duck Mouth Bath



Float Line Tensioner



Inline chlorine feeder



Line Rope Accessory



Swimming Pool Ladder



Side Mounted Filter



UV Sterilizer



Life Gaurd Chair



Float Line Heavy Type tensioner



Swimming Pool Pump



TCCA - 90 Chemical



LED Light



Top Mounted Filter



Telescopic Pole



Umbrella



Swimming Pool Jets



Suction Vacuum Head



S.S. LED Light

Swimming Pool accessories



Pool Counterflow Jet



Pool lifebuoy



Skimmer



Pool Cover Roller



Pool Life Jacket



Online Heater



Pipe Less Filter



Robotic Pool Cleaner



lounger



Leaf Net



Heat Pump



Gratings



Float Line Plastic Tensioner



Dosing Pump



Commercial Air Blower



Pipe and Fittings



Racing Lane Trolley



Starting Blocks



Virhy Water Bed



Test Kit



Float Line Hook



Cartage Filler

SS Panel Swimming Pool



Stainless Steel Swimming Pool constructed by SS plates with covering of fiber supportive panel walls depending on the size and design of the swimming pool. In this kind of swimming pool we used liner inside the swimming pool. SS Panel takes support of concrete outside the swimming pool. Liner provides smooth finish, nice look and easy to install. Filtration plant installed outside the swimming pool a bit plumbing work required.

| Key | Part Description |
|-----|--------------------|
| 1 | Vertical |
| 2 | Joint |
| 3 | Rail |
| 4 | Plastic Edging |
| 5 | Top Seat |
| 6 | Seat Cover Bracket |
| 7 | Seat Cover |
| 8 | Wall |

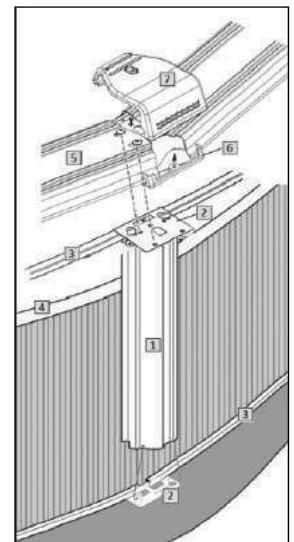

Model No. - H.P. 20

» **Size - 12'Round x 4', 16' x 12' x 4', 18' x 9' x 4'**



Types of Spa Bath-The Best Spa Baths for Your Body

- 1 Soothe your muscles, detoxify your skin, and quiet your mind with a trip to the tub

Hydro Plus's Spa models are technological marvels, created to let you relax and restore equilibrium. Hydro Plus's 'well being circuits' comprise of various seats and a common footrest in the centre. Each seat is strategically fitted with different types of Massage jets in various positions, oriented to massage different parts of the body. By moving from one seat to the other, one can enjoy a complete and satisfying massage which stimulates and relaxes all parts of the body. Cushioned headrests, ergonomic seats and a host of high performance features make this the ultimate home spa experience.



Inflatable Spa Pool



Above ground inflatable Spa Pool with spa function that are a lot cheaper, safer, quicker to install and more enjoyable than the permanent ones. We make it easier for you and your family to beat the summer heat without going anywhere.

Model No.- H.P.31

- » Size :- 71"x 21"
- » Capacity :- 4 Persons
- » Water Capacity :- 800 Ltr.
- » Filled Weight :- 1,026 Kg
- » Rating :- 220 - 240V ~ 50Hz 2, 050W at 20°C
- » Actual Water Flow :-> 1,325 L / h
- » Rapid Heating System :- Approx. 1.5-2.0°C / h (3-4°F / h)
- » Max. Heat Capacity :- 40°C (104°F)

Model No.- H.P.32

- » Size :- 77"x 24"
- » Capacity :- 4 Persons
- » Water Capacity :- 848 Ltr.
- » Filled Weight :- 1,100 Kg
- » Rating :- 220 - 240V ~ 50Hz 2, 050W at 20°C
- » Actual Water Flow :-> 1,325 L / h
- » Rapid Heating System :- Approx. 1.5 - 2.0°C / h (3-4°F / h)
- » Max. Heat Capacity :- 40°C (104°F)



Model No. - H.P.111

Spa Bath Tubs for 4 Person

Size :- 6' x 5' x 2'5"

- » Jacuzzi bath Pump 1.5 H.P 3 Pcs. with 16 Big jet 8 Micro jet.
- » Bubble Bath with 12 Jet.
- » Filtration Plant With 0.5 Hp Pump.
- » Under Water Light 3 pcs.
- » Bath Tubs Filler 1 pcs.
- » Online Heater 4.5 K.w.(optional)
- » Over flow Greeting.
- » Pup - up Waste.
- » S.Steel Stand.
- » Four Side Panel.
- » Air Controller 3 pcs.
- » Gate valve 3 pcs.



Spa Bath

FRP/ Acrylic



Model No. - H.P.112

Spa Round for 6 Person

Size:- 8' Round x 3' w / o Round Panel

- » Jacuzzi pump 1.5H.P 2pcs, 2H.P 1pcs 18 Big jet 12 Micro jet.
- » Bubble Bath 1H.P Air Blower With 20 Jet.
- » Filter plant With 1. H.P. Pump 1Pcs.
- » Under Water Light 3 PCs.
- » Online Heater 4.5 KW.(optional)
- » Bath Filler
- » Drain Greeting.
- » Pup UP Waste.
- » SS. Stand.
- » Air Regulator 4 PCs.
- » Gate Valve 6 PCs.





Model No.- H.P.113

Spa For 6 Person

Size :- 7' x 7' x 3' with Panel

- » Jacuzzi pump 1.5H.P 1pcs, 2H.P 1pcs 10 Big jet 12 Micro jet.
- » Bubble Bath 1H.P Air Blower With 20 Jet.
- » Filter plant With 1. H.P Pump 1Pcs.
- » Under Water Light 3 PCs.
- » Online Heater 4.5 KW.(optional)
- » Bath Filler
- » Drain Greeting.
- » Pup UP Waste.
- » SS. Stand.
- » Air Regulator 4 PCs.
- » Gate Valve 6 PCs





Types of Sauna Bath

- 1 **Traditional Sauna** - Soothing the mind and body, a sauna, increases blood flow circulation bringing nutrients to subcutaneous and surface tissue resulting in a glowing healthy skin, regulates metabolism, promotes the natural healing process eventuating quicker recoveries from fatigue and injury etc. Likewise, granting the pleasure of stretching out, relaxing and completely cleansing yourself.

Specification - Sauna Room is constructed using a frame work 35mm x 50mm pine wood cross sections at a distance of 450mm x 450mm (c / c).The entire surface is covered with 25 mm thick resin bonded high- density glass wool wrapped in aluminum foil. The entire frame is sealed with water proof, the inside of the sauna room is then covered on all six sides (including floor& roof) By 12 mm x 95 mm & For Floor & Bench 18 mm x 95 mm pine wood strips using tongue & groove joints. Louvers are provided for balanced ventilation.

- 2 **Infrared Sauna**

Note: The temperature in the sauna should be between 60-100°C with very dry air inside, allowing perspiration to quickly evaporate.

Upon entering the sauna, the body is warmed in the hot environment and perspiration increases. Exiting the heat and chilling the body in cold water after the sauna is an inseparable part of the sauna experience. It cleans out poisons from the body and of course, it is a mentally and physically relaxing experience.



Uncomplicating the sauna experience
(Sauna Unit Details to Suit your Calm)

FEATURES & TECHNICAL DETAILS

| Detail | Advantage |
|---|--|
| Microprocessor based Technology Auto Cut off | The circuit PCB is based on marvel technology with Digital Display. It shuts down the machine after the set time & room temperature. No need to remember to put it off. |
| Time/ Temp.Display Light On/ Off | On Control Panel. One may switch on/off the light of steam room with the switch provided on digital display panel. |
| Internal wiring in Sauna Room | It is done with Teflon wire that can tolerate the high temperature & is fire safe. |
| Sauna Heater Internal Body | Stainless Steel 202 Grade |
| External Body | Stainless Steel 304 Grade. |
| Heating element | Stainless Steel 316 Grade. |
| Sauna Generators | Commercial use heavy duty |
| Panic Button With Buzzer | For Emergency Push the button all system off & on buzzer |

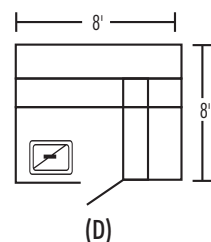
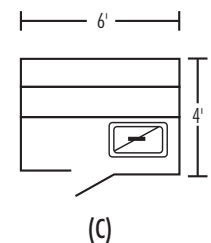
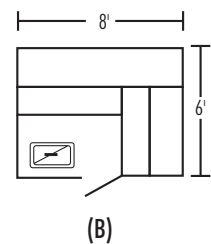
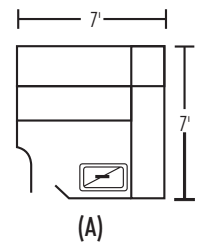

TECHNICAL DATA

| KW Rating | Max Recommended Room Volume Cu. ft | Supply Voltage (V), 50Hz | Phase | MCB | | Wire Size mm ² | Dimension |
|-----------|------------------------------------|--------------------------|--------|-------------|------|---------------------------|-----------------|
| | | | | Amps Rating | Type | | |
| 4.5 | 135-150 | 230 | Single | 32A | DP | 4 | 15" x 10" x 20" |
| 6 | 180-200 | 230 | Single | 40A | DP | 4 | 15" x 10" x 20" |
| 9 | 270-300 | 415 | Three | 40A | TPN | 4 | 15" x 10" x 20" |
| 12 | 370-400 | 415 | Three | 50A | TPN | 6 | 15" x 10" x 20" |
| 15 | 450-500 | 415 | Three | 63A | TPN | 6 | 15" x 15" x 20" |
| 18 | 550-600 | 415 | Three | 80A | TPN | 6 | 20" x 20" x 20" |

Infrared Sauna



Radiations are experienced as the heating component of the natural sunlight. Far Infrared is a completely safe form of natural light energy and essential for all living things. Infrared Radiation is shown to induce 2-3 times the sweat volume of traditional heat and steam saunas, with a lot less discomfort, and the sweat contains more toxins from the deeper fatty tissue layers below the skin.

Our flagship product Infrared Sauna not only provide unlimited health benefits but also offer a completely rejuvenating experience in just 20 minutes. You are welcome to have a personal experience at our showroom. It is a very Eco friendly and energy saving equipment and very easy to run and maintain it.

Far infrared saunas provide the following health benefits:

- » Better Circulation and Increased Energy
- » Weight Loss Aid
- » Maintain Cardiovascular Health
- » Speed Recovery from Injuries
- » Detoxification
- » Stress Reduction & Relaxation
- » Skin Beauty
- » Improved Immune System

For better understanding the utility and benefits, We can send you on request Medical data and some case studies & Doctors opinions on Infra -RED sauna which clearly speaks about the benefit for this latest technology. We want you to make your life healthy without any extra efforts. We always call it `Your active way to perfect health`. It Re-energize, re-charge, De-stress & De-toxify your Mind, Body & Soul. Studies show that it can burn 600 calories in just 20 mins.



SEK - B2 (2 Person Sauna)

| | |
|----------------|--------------------|
| Dimensions | 1200*1200*1900(mm) |
| Heater | 5 Heater |
| Power | 1700 W |
| Wood Material | Hemlock |
| Operating Temp | 30 - 60°C |

H.P - CP2 (2 Person Sauna)

| | |
|----------------|--------------------|
| Dimensions | 1200*1200*1900(mm) |
| Heater | 2 Panel + 4 Heater |
| Power | 1710 W |
| Wood Material | Hemlock |
| Operating Temp | 18 - 60°C |



Towel Rack



Color Therapy Lights



Cup Holder



Multi-direction Magnetic Therapy system



Soft Touch Controls



Temperature Sensor & Ventilation

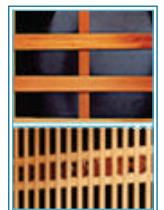

Carbon/Ceramic Heaters



CD/ FM/ AM Stereo



Book Shelf



Oxygen Ionizer

SEK - P02R (2 Person Sauna)

| | |
|----------------|--------------------|
| Dimensions | 1200*1200*1900(mm) |
| Heater | 8 Heater (Carbon) |
| Power | 1920 W |
| Wood Material | Hemlock |
| Operating Temp | 30 - 60°C |

Steam Bath



The **Steam Bath** is totally different from bathing. A steam generator located outside the steam room itself produces clouds of soothing steam in which to bath. The 100% humidity means that for most people, the bathing temperature is most comfortable at around 40°C - 45°C.

Steam Bathing is an excellent treatment for respiratory problem, pain relief, and grants better immunity, it enhances the detoxifying capacity of skin by opening pores and flushing impurities from the body, it revives tired and strained muscles after physical exertion. You will discover that a steam bath ahead of bath time is an excellent method of promoting a deep restful sleep.

The bathing timing limit is 10 -15 minutes. Do not push your body beyond its comfort levels. Drink plenty of water before and after the steam bath to replace fluids lost during bathing.

We are counted among successful Manufacturer, Importer and supplier of Steam Bath. Steam Bath is basically designed by us keeping in mind the various requirements of client to relieve stress. It is very affordable and hence can serve to every class of people. The material used by us in making Steam Bath is of supreme quality.

Note - The use of alcohol, drugs or medication can greatly increase the risk of total hyperthermia.



Model No.-EL 200
Steam Generator
with Control Panel

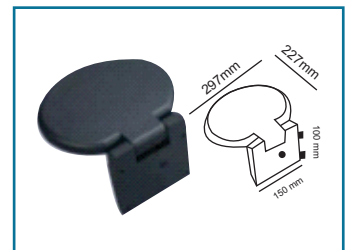

Steam Chair



LED Light



Steam Outlet

FEATURES & TECHNICAL DETAILS

| Detail | Advantage |
|---------------------------------|---|
| Microprocessor Based Technology | The circuit PCB is based on marvel technology with Digital Display. |
| Auto Cut off | It shuts down the machine after the set time & room temperature. No need to remember to put it off. |
| Time / Temp.Display | On Control Panel. |
| Light On / Off | One may switch on/off the light of steam room with the switch provided on digital display panel. |
| Internal Wiring in Steam Room | It is done with Teflon wire that can tolerate the high temperature & is fire safe. |
| Steam Generator Internal Body | Stainless Steel 304 Grade |
| External Body | Stainless Steel 304 Grade. |
| Heating Element | Stainless Steel 316 Grade. |
| Steam Generators | Commercial use heavy duty type. |
| Panic Button With Buzzer | For Emergency Push the button all system off & on buzzer |
| 100% Safety | The unit is pressure barred. The steam room is never blocked Additional safety valve is also incorporated. |
| Instant Steam | The Steam room is ready for use in less than 5 Minutes depending on ambience temp. |
| Auto Water Level Sensor | It Maintains the water level. Automatically switches off the machine in case water supply is interrupted due to any reason. |

TECHNICAL DATA

| KW Rating | Max Recommended Room Volume Cu. ft | Supply Voltage (V), 50Hz | Phase | MCB | | Wire Size mm ² | Dimension |
|-----------|------------------------------------|--------------------------|--------|-------------|------|---------------------------|-------------|
| | | | | Amps Rating | Type | | |
| 4.5 | 80-100 | 230 | Single | 32A | DP | 4 | 22"x6"x15" |
| 6 | 120-140 | 230 | Single | 40A | DP | 4 | 25"x7"x15" |
| 9 | 180-200 | 415 | Three | 40A | TPN | 4 | 27"x10"x19" |
| 12 | 240-270 | 415 | Three | 63A | TPN | 6 | 27"x10"x19" |
| 15 | 300-330 | 415 | Three | 63A | TPN | 6 | 30"x13"x23" |
| 18 | 300-400 | 415 | Three | 80A | TPN | 6 | 30"x13"x23" |

Bath Cabin



A shower enclosure is no longer just a square or rectangular stall. Now they certainly have the power to transform an average bathroom into a real modern luxury oasis.

Hydroplus has stunning style and thoughtful practicality characterise these shower enclosure series offering an unobstructed view of your surroundings as you shower these enclosures. Optimize space utilization, block the water better keeping your floors drier. Available in a variety of different versions they can be combined with many different shower bases.

So, make the most of your bathroom with these elegant and essential bathroom conventions.

- » Powder Coating Aluminum with Acrylic Sheet
- » Powder Coating with 5mm Toughened Glass
- » Frame Less Cabin with 10mm Toughened Glass Kolf or Ozone Fitting



Model No. - H.P.M.S- 201

Size: 1200mmx1200mm, 1000mmx1000mm, 900mmx1200mm

- » 3.8mm Acrylic Sheet
- » 6.0mm Toughened Safety Glass
- » Rain Shower
- » Ceiling Lamp
- » Ventilation Fan
- » Hi-Fi Speaker
- » FM Radio
- » Microcomputer Control Panel
- » Handhold Shower
- » Mixing Valve
- » 6 Water Massage Back Jet
- » Foot Massage Device
- » Steam Generator
- » Ozone Disinfection
- » Temperature Detector

Model No. - H.P.M.S- 202

Size: 1200mmx1800mm

- » Tub with Jacuzzi System
- » 3.8mm Acrylic Sheet
- » 5.0mm Toughened Safety Glass
- » Rain Shower
- » Ceiling Lamp
- » Ventilation Fan
- » FM Radio with Hi-Fi speaker
- » Microcomputer Control Panel
- » Handhold Shower
- » Mixing Valve
- » 6 Water Massage Back Jet
- » Foot Massage Device
- » Steam Generator
- » Ozone Disinfection
- » Temperature Detector





Acrylic bathtubs are vacuum-molded from sheets of acrylic and reinforced with fiberglass. Inexpensive and effortless, these beautiful tubs are non-porous, hi-gloss, and resistant to the rigors of everyday life - no cracks, no chips.

Easy and simple to maintain, these lightweight tubs are ideal for whirlpool systems and perfect for those who enjoy long bubble baths before a difficult day at the work or after a long trying day of running errands.



Model No.- H.P.B- 1001

GRACE (R)

Size:- 6' x 4.3' with Front Panel / S.S.Stand

- » Whirlpool Pump 1.5 H.P. 1 pcs. 6 Big jet, 4 Micro jet.
- » Bubble Bath jet 12 pcs. Air Blower AP - 300.
- » F.M. Kit with Control Panel.
- » Under Water Light (LED).
- » Online Heater.
- » Pop up waste.
- » Head Rest 2 pcs.
- » Grip Bar 1 pcs.
- » Bath Tub Filler.

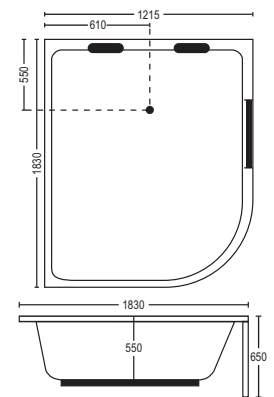

Model No.- H.P.B- 1002

GRACE (L)

Size:- 6' x 4' with Front Panel / S.S.Stand

- » Whirlpool Pump 1.5 H.P. 1 pcs. 6 Big jet, 4 Micro jet.
- » Bubble Bath jet 12 pcs. Air Blower AP - 300.
- » F.M. Kit with Control Panel.
- » Under Water Light (LED).
- » Online Heater.
- » Pop up waste.
- » Head Rest 2 pcs.
- » Grip Bar 1 pcs.
- » Bath Tub Filler.

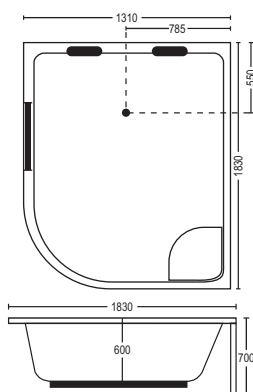

Bath Tub



Model No. - H.P.B- 1003

SEAGULL

Size:- 6' x 5', 6' x 4'6", 6' x 4' with Front Panel / Side Panel / S.S. Stand

- » Whirlpool Pump 1.5 H.P. 1 pcs.
6 Big jet, 4 Micro jet.
- » Bubble Bath jet 12 pcs.
Air Blower AP - 300.
- » F.M. Kit with Control Panel.
- » Under Water Light (LED).
- » Online Heater.
- » Pop up waste.
- » Head Rest 2 pcs.
- » Bath Tub Filler.

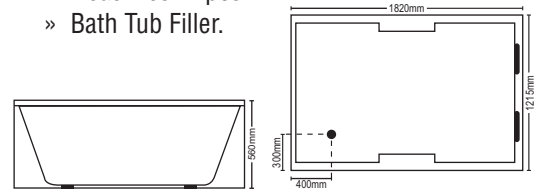

Model No. - H.P.B- 1004

OSCAR

Size:- 6' x 4' with Front Panel / Side Panel / S.S. Stand

- » Whirlpool Pump 1.5 H.P. 1 pcs. 6 Big jet, 4 Microjet.
- » Bubble Bath jet 10 pcs. with Air Blower AP - 300.
- » F.M. Kit with Control Panel.
- » Under Water Light (LED).
- » Bath Tub Filler.
- » Online Heater
- » Pop up waste.
- » Head Rest 2 pcs.

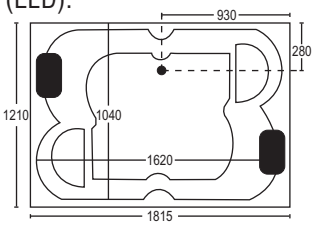



Model No. - H.P.B-1005

SEAGULL W

**Size:- 6' x 5', 6'0" x 4'6", 6'x 4', 6'0" x 3'6",
6' x 3' with Front Panel / Side Panel /
S.S. Stand**

- » Whirlpool Pump 1.5 H.P. 1 pcs. 6 Big jet, 4 microjet.
- » Bubble Bath jet 10 pcs. with Air Blower AP - 300.
- » F.M. Kit with Control Panel.
- » Under Water Light (LED).
- » Bath Tub Filler.
- » Online Heater.
- » Pop up waste.
- » Head Rest 2 pcs.

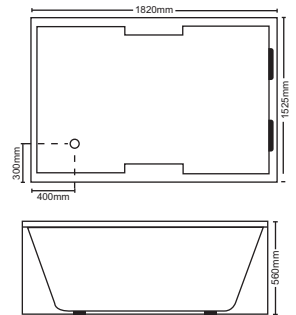

Model No. - H.P.B-1006

FAMILY FUN

**Size:- 6' x 6'with Front Panel / Side Panel /
S.S. Stand**

- » Whirlpool Pump 1.5 H.P. 1 pcs. 6 Big jet, 4 microjet.
- » Bubble Bath jet 10 pcs. with Air Blower AP - 300.
- » F.M. Kit with Control Panel.
- » Under Water Light (LED).
- » Bath Tub Filler.
- » Online Heater.
- » Pop up waste.
- » Head Rest 4 pcs.

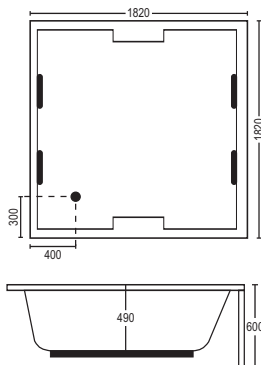



Model No. - H.P.B- 1007

SEAGULL

Size:- 5'6" x 4' with Front Panel / Side Panel / S.S. Stand

- » Whirlpool Pump 1.5 H.P. 1 pcs. 6 Big jet, 4 microjet.
- » Bubble Bath jet 10 pcs. with Air Blower AP - 300.
- » F.M. Kit with Control Panel.
- » Under Water Light (LED).
- » Bath Tub Filler.
- » Online Heater.
- » Pop up waste.
- » Head Rest 2 pcs.

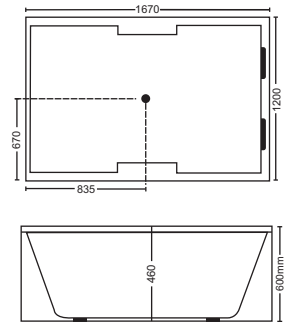

Model No. - H.P.B-1008

LANCER

Size:- 6' x 3'6" with Front Panel / Side Panel / S.S. Stand

- » Whirlpool Pump 1.5 H.P. 1 pcs. 6 Big jet, 4 microjet.
- » Bubble Bath jet 10 pcs with Air Blower AP - 300.
- » F.M. Kit with Control Panel.
- » Under Water Light (LED).
- » Bath Tub Filler.
- » Online Heater.
- » Pop up waste.
- » Head Rest 2 pcs.

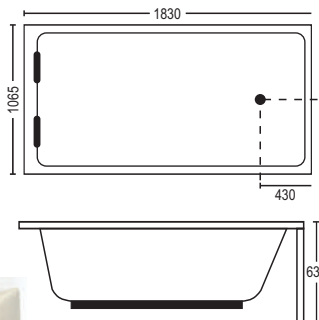



Model No.- H.P.B- 1009

TURBO CLASSIC

Size:- 5' Corner with Front Panel / S.S. Stand

- » Whirlpool Pump 1.5 H.P. 1 pcs. 6 Big jet, 4 microjet.
- » Bubble Bath jet 10 pcs. with Air Blower AP - 300.
- » F.M. Kit with Control Panel.
- » Under Water Light (LED.)
- » Bath Tub Filler.
- » Online Heater.
- » Pop up waste.
- » Head Rest 3 pcs.

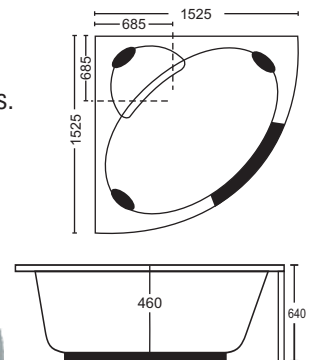

Model No.- H.P.B- 1010

TURBO - XL DELUXE

Size:- 5' Corner with Front Panel / S.S. Stand

- » Whirlpool Pump 1.5 H.P. 1 pcs. 6 Big jet, 4 microjet.
- » Bubble Bath jet 10 pcs. with Air Blower AP - 300.
- » F.M. Kit with Control Panel.
- » Under Water Light (LED).
- » Bath Tub Filler.
- » Online Heater.
- » Pop up waste.
- » Head Rest 2 pcs.

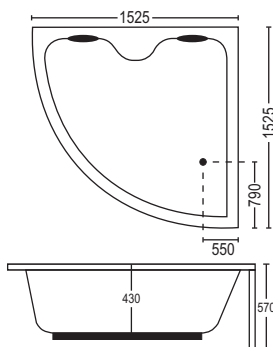

Bath Tub



Model No. - H.P.B- 1011

GIVO

Size:- 4'6" Corner with Front Panel / S.S Stand

- » Whirlpool System 1.5 H.P 1 pcs. 6 Big Jet
- » Bubble Bath 10 jet with Air Blower A.P - 300.
- » Micro jet 2 pcs.
- » Bath Tub Filler.
- » Head Rest 1 pcs.
- » Online Heater.
- » Under Water Light (LED).
- » Pop up waste.
- » Grip Bar.
- » F.M. Kit with Control Panel (**Optional**).

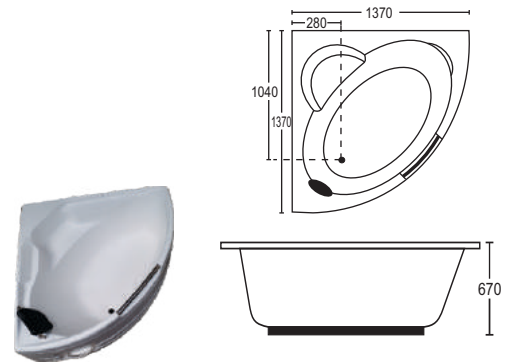

Model No. - H.P.B- 1012

SPACIO

Size:- 4'6" Corner with Front Panel / S.S. Panel

- » Whirlpool Pump 1.5 H.P. 1 pcs, 6 Big jet.
- » Bubble Bath jet 10 pcs. with Air Blower AP - 300.
- » F.M. Kit with Control Panel.
- » Under Water Light (LED).
- » Bath Tub Filler.
- » Online Heater.
- » Pop up waste.
- » Head Rest 1 pcs.

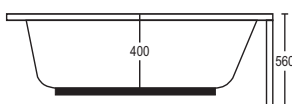
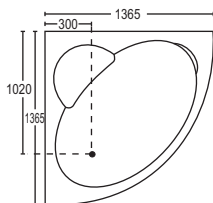



Model No.- H.P.B- 1013

VIVA

Size:- 4' Corner with Front Panel / S.S. Panel

- » Whirlpool Pump 1.5 H.P. 1 pcs, 6 Big jet.
- » Bubble Bath jet 10 pcs. with Air Blower AP - 300.
- » F.M. Kit with Control Panel.
- » Under Water Light (LED).
- » Bath Tub Filler.
- » Online Heater.
- » Pop up waste.
- » Head Rest 1 pcs.

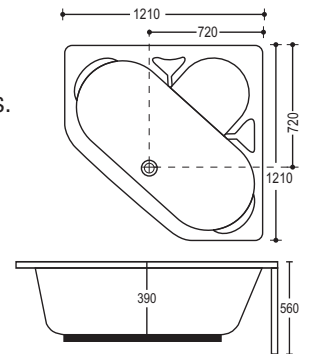

Model No.- H.P.B- 1014

TURBO

Size:- 4'6" Corner with Front Panel / S.S. Panel

- » Whirlpool Pump 1.5 H.P. 1 pcs, 6 Big jet.
- » Bubble Bath jet 10 pcs. with Air Blower AP - 300.
- » F.M. Kit with Control Panel.
- » Under Water Light (LED).
- » Bath Tub Filler.
- » Online Heater.
- » Pop up waste.

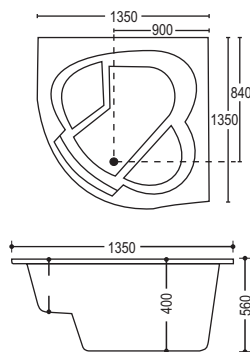

Bath Tub



Model No. - H.P.B-1015

CLASSIC OCEAN

Size:- 6' Round / S.S. Stand

- » Whirlpool Pump 1.5 H.P. 1 pcs. 6 Big jet.
- » Bubble Bath jet 10 pcs. with Air Blower AP - 300.
- » F.M. Kit with Control Panel.
- » Under Water Light (LED).
- » Bath Tub Filler.
- » Online Heater.
- » Pop up waste.
- » Head Rest 4 Pcs.

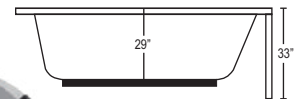
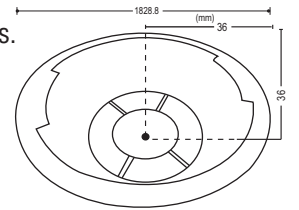

Model No. - H.P.B- 1016

MADERIA

Size:- 6' Round / S.S. Stand

- » Whirlpool Pump 1.5 H.P. 1 pcs. 6 Big jet.
- » Bubble Bath jet 10 pcs. with Air Blower AP - 300.
- » F.M. Kit with Control Panel.
- » Under Water Light (LED).
- » Bath Tub Filler.
- » Online Heater.
- » Pop up waste.

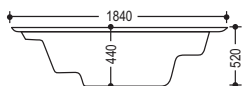
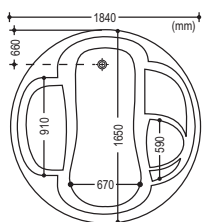



Model No.- H.P.B- 1017

CLASSIC

Size:- 5' Round with Panel

- » Whirlpool Pump 1.5 H.P. 1 pcs. 6 Big jet.
- » Bubble Bath jet 10 pcs. with Air Blower AP - 300.
- » F.M. Kit with Control Panel.
- » Under Water Light (LED).
- » Bath Tub Filler.
- » Online Heater.
- » Pop up waste.

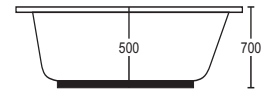
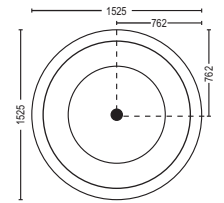

Model No.- H.P.B- 1018

VERONA

Size:- 5' Round with Round Panel / S.S, Panel

- » Whirlpool Pump 1.5 H.P. 1 pcs. 6 Big jet.
- » Bubble Bath jet 10 pcs. with Air Blower AP - 300.
- » F.M. Kit with Control Panel.
- » Under Water Light (LED).
- » Bath Tub Filler.
- » Online Heater.
- » Pop up waste.

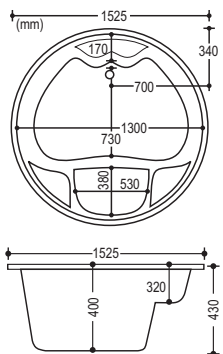



Model No. - H.P.B- 1019

SMART ROUND

Size:- 5' Round / S.S. Stand

- » Whirlpool Pump 1.5 H.P. 1 pcs. 6 Big jet.
- » Bubble Bath jet 10 pcs. with Air Blower AP - 300.
- » F.M. Kit with Control Panel.
- » Under Water Light (LED).
- » Bath Tub Filler.
- » Online Heater.
- » Pop up waste.
- » Head Rest 2 Pcs.

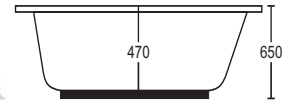
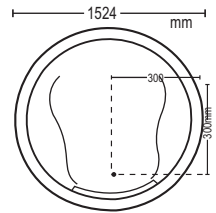

Model No. - H.P.B- 1020

LANCER

Size:- 5'6" x 2'6", 6' x 3', 5' x 3', 4'6" x 2'6",
4'6" x 2'3", 5' x 2'6" with Front Panel /
Side Panel / S.S. Stand

- » Whirlpool Pump 1.5 H.P. 1 pcs. 6 Big jet.
- » Bubble Bath jet 10 pcs. with Air Blower AP - 300.
- » F.M. Kit with Control Panel.
- » Under Water Light (LED).
- » Bath Tub Filler.
- » Online Heater.
- » Pop up waste.
- » Head Rest 1 pcs.

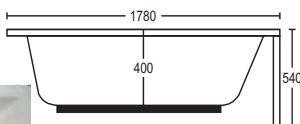
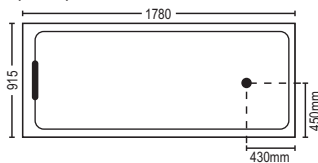

Model No. - H.P.B-1021

QUATTRO

Size:- 6' x 3'3" with Front Panel / Side Panel / S.S. Panel

- » Whirlpool Pump 1.5 H.P. 1 pcs. 6 Big jet.
- » Bubble Bath jet 10 pcs. with Air Blower AP - 300.
- » F.M. Kit with Control Panel.
- » Under Water Light (LED).
- » Bath Tub Filler.
- » Online Heater.
- » Pop up waste.
- » Head Rest 1 pcs.

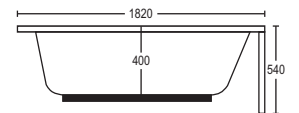
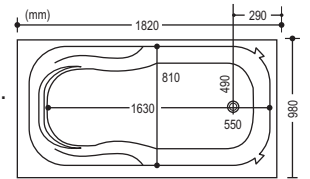

Model No. - H.P.B-1022

REGULAR

Size:- 5'6" x 2'6" with Front Panel / Side Panel / S.S. Stand

- » Whirlpool Pump 1.5 H.P. 1 pcs. 6 Big jet.
- » Bubble Bath jet 10 pcs. with Air Blower AP - 300.
- » F.M. Kit with Control Panel.
- » Under Water Light (LED).
- » Bath Tub Filler.
- » Online Heater.
- » Pop up waste.
- » Head Rest 1 pcs.

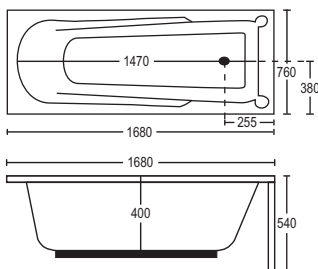

Bath Tub



Model No. - H.P.B-1023

ROVAL

Size:- 6' x 2'6" with Front Panel / Side Panel / S.S Stand

- » Whirlpool Pump 1.5 H.P. 1 pcs. 6 Big jet.
- » Bubble Bath jet 10 pcs. with Air Blower AP - 300.
- » F.M. Kit with Control Panel.
- » Under Water Light (LED).
- » Bath Tub Filler.
- » Online Heater.
- » Pop up waste.
- » Head Rest 1 pcs.

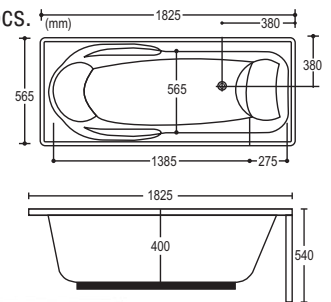

Model No. - H.P.B-1024

UTILITI

Size:- 6' x 3' with Front Panel / Side Panel / S.S. Panel

- » Whirlpool Pump 1.5 H.P. 1 pcs. 6 Big jet
2 Micro jet.
- » Bubble Bath jet 12 pcs. Air Blower AP - 300.
- » F.M. Kit with Control Panel.
- » Under Water Light (LED).
- » Online Heater.
- » Pop up waste.
- » Head Rest 1 PCS.

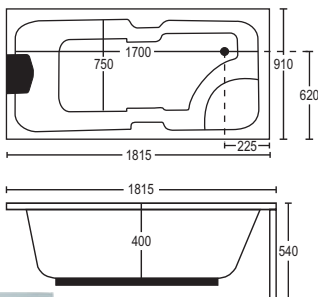

Model No. - H.P.B-1025

LANCER NEW

Size:- 5'8" x 2'8" with Front Panel / Side Panel / S.S. Stand

- » Whirlpool Pump 1.5 H.P. 1 pcs. 6 Big jet, 2 Microjet.
- » Bubble Bath jet 10 pcs. with Air Blower AP - 300.
- » F.M. Kit with Control Panel (**Optional**).
- » Under Water Light (LED).
- » Bath Tub Filler.
- » Online Heater (**Optional**).
- » Pop up waste.
- » Head Rest 1 pcs.

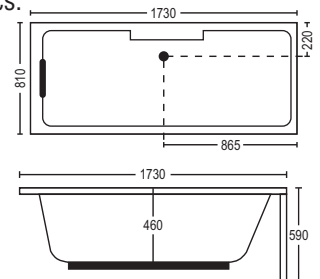

Model No. - H.P.B-1026

REGULAR

Size:- 6' x 3' S.S. Stand / Acrylic Bath Tub Heavy Duty

- » Whirlpool Pump 1H.P. 6 Jets.
- » Under Water LED Light.
- » Hot & Cold Mixing Valve with Handhold Shower & Waterfall Spout.
- » Microcomputer Control Panel with Hi-Fi Speaker & FM Radio
- » Towel Rod & Shampoo Stand.
- » Air Pump with 12 Air Jets
- » Pop up waste.
- » Online Heater
- » LED TV

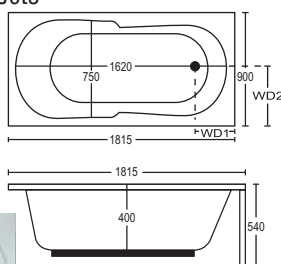



Model No. - H.P.B-1027

OSCAR DELUXE

Size:- 6' x 3' with Front Panel / S.S. Stand

- » Whirlpool Pump 1.5 H.P. 1pcs.
- » 6 Big jet 2 Micro jet.
- » Bubble Bath jet 12 pcs. Air Blower AP - 300.
- » F.M. Kit with Control Panel.
- » Under Water Light (LED).
- » Online Heater.
- » Pop up waste.
- » Head Rest 1 PCS.

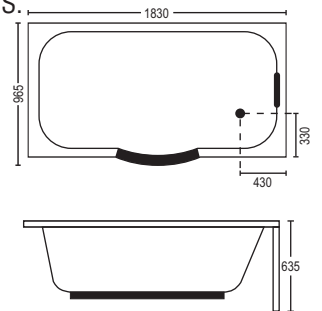

Model No. - H.P.B-1028

ANTIQUITY

Size:- 5'3" x 2'6"

- » Bath Tub Filler.
- » Pup UP Waste.
- » 4 Leg (Brass).

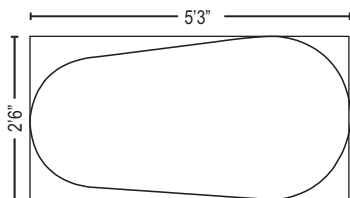



Model No. - H.P.B-1029

VALIO

Size:- 5'6" x 2'6" with Front Panel / S.S. Stand

- » Whirlpool Pump 1.5 H.P. 1pcs. 6 Big jet 2 Micro jet.
- » Bubble Bath jet 12 pcs. Air Blower AP - 300.
- » F.M. Kit with Control Panel (**Optional**).
- » Under Water Light (LED).
- » Online Heater (**Optional**).
- » Pop up waste.
- » Head Rest 1 PCS.

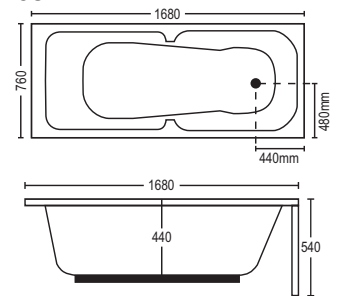

Model No. - H.P.B-1030

EGG CLASSIC

Size:- 5'7" x 2'6" with Front Panel / S.S. Stand

- » Whirlpool Pump 1.5 H.P. 1pcs.6 Big jet.
- » Bubble Bath jet 12 pcs. Air Blower AP - 300.
- » F.M. Kit with Control Panel (**Optional**).
- » Under Water Light (LED).
- » Online Heater (**Optional**).
- » Pop up waste.

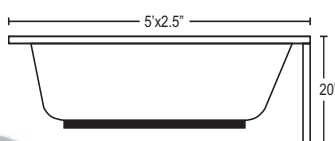
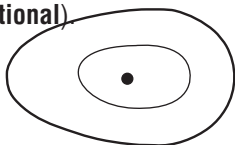

Whirlpools System/ Jacuzzi

Hydro therapeutic massage stimulates blood circulation, relieves fatigue and tones muscles.

Our whirl pool system converts any previously installed bath tub into a luxurious making installation inside the tub walls a quick and simple procedure. When the retrofitting is complete, the tub looks and performs as if it had been originally installed as a factory whirlpool unit.

The big benefit of having an indoor Jacuzzi versus an outdoor Jacuzzi is that you will be able to use it more frequently. You can always use an indoor Jacuzzi regardless of what the weather outside.

Another benefit of using an indoor Jacuzzi is that is safer. You are in the comfort of your own home and you do not have to worry about anything going on outside while you are relaxing.

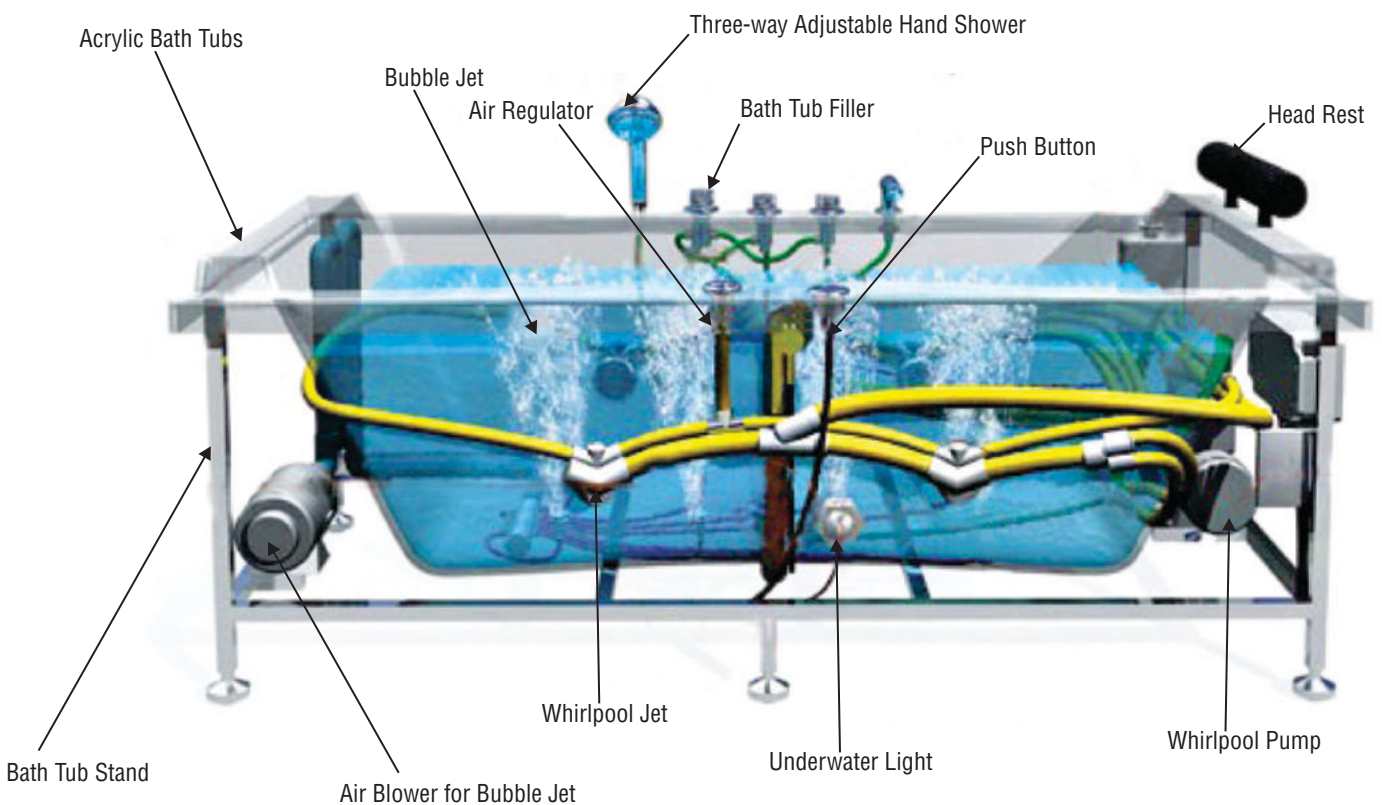

Standard Whirl Pool Kit

- » One Pump 1 H.P., 1.5 H.P., 2 H.P., 3 H.P.
- » Six Whirlpool Jet Sets
- » One Push Button
- » One Pressure Control
- » One Section Fitting

Optional

- » Bubble Bath with Air Blower
- » Bubble Bath LED Light With Air Blower
- » Online Heater
- » Bath Tub Filler- Spout, Head Shower, Diverter
- » Bath Tubs Pop- up waste Over Flow
- » Control Panel with water level sensor without FM
- » Micro Jet Set 2 pcs.
- » Under Water Light
- » Head Rest
- » FM Kit



Whirlpool Jet Kit with Pump
1 H.P., 1.5 H.P., 2 H.P.



Whirlpool Jet-A



Whirlpool Jet-B



Whirlpool Jet-C



Micro Jet-A



Micro Jet-B



Bubble Bath Jet Kit with Brass Jet



Bubble Bath Jet Kit with ABS Jet



Bath Tubs Filler-A



Bath Tubs Filler-B

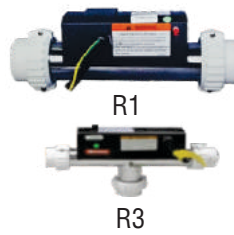

Online Heater 2 & 3 K.W

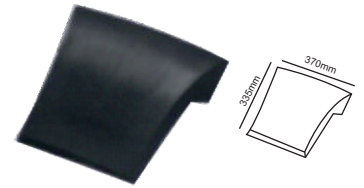

Head Rest-A



Head Rest-B



Head Rest-C



Bath Tubs Pop-up waste over flow



LED light



Control Panel



FM Kit



LED Bubble Bath



Ozonator



Air Switch



Pipe

Chiller Bath



| |
|-----------------------------|
| 100 Lts. |
| 200 Lts. |
| 300 Lts. |
| 400 Lts. |
| 500 Lts. |
| Higher Capacities |
| Available Capacities |

| FEATURES & TECHNICAL DETAILS | |
|------------------------------|--|
| Description | Technical Specification |
| Machine | Chilling Plant ordered Lts Storage capacity made of S.S. 304 Sheet (inner) & (outer) with puff insulation. With a digital control. |
| Compressor | Sealed type Kirloskar Copland make having suitable capacity using R 22. Refrigerant gas with contactor relay. |
| Condenser | Air-cooled type made up of all fins and finned copper tubes with Fan & motor. |
| Cooling Coil | Copper Cooling coil soldered to the outer surface of inner tank. |
| Presser Pump | Suitable For Bath Room. |

Chilled Shower is mandatory after Sauna & Steam bathing to get most rejuvenating experience. Chilled water pressure bath rejuvenates the body after a hot sauna or steam bath. The water temperature maintained is 7^oc to 12^oc. Hot Sauna or Steam open the pores of steam bath and chilled pleasure Shower cleans the skin & cossets the pores back to normal leaving behind a soft smooth, clean skin and a refreshing feeling. Research indicates that chilled water bath provides muscle simulation and also enhances mental ability reducing stress level.

Dirty Water Pump in P.P. Body



These pumps are available in different options. They are used for emptying underground & flooded basements. The float switch can automatically control on/off with the change of the liquid level. A non- return valve installed on the delivery pipes avoids reverse flow when the pump steps . They come in variety of motor shells and impeller types.

Features

- Continuous duty pumps maintain performance specifications at 100% duty cycle.
- The float switch can automatically control on / off with the change of the liquid level.

TECHNICAL DATA

| Brand | Model | Watt | Rate Head (in Mtr.) | Rate Discharge (in LPH) | Grain Size (in mm) | Pipe Size (in mm) |
|-------|---------|------|------------------------|----------------------------|-----------------------|----------------------|
| kaps | KQ750B2 | 750 | 7.5 | 13,000 | 35 | 25, 32, 40 |

Dirty Water Pumps in S.S. Body



These pumps are available in different options. They are used for emptying underground & flooded basements. The float switch can automatically control on/off with the change of the liquid level. A non- return valve installed on the delivery pipes avoids reverse flow when the pump steps . They come in variety of motor shells and impeller types.

Features

- Continuous duty pumps maintain performance specifications at 100% duty cycle.
- Run dry capable pumps can operate without pumped fluid or external lubrication for an extended period of time

TECHNICAL DATA

| Brand | Model | Watt | Rate Head (in Mtr.) | Rate Discharge (in LPH) | Grain Size (in mm) | Pipe Size (in mm) |
|-------|-----------|------|------------------------|----------------------------|-----------------------|----------------------|
| kaps | KQ750B65H | 750 | 7.5 | 13,000 | 35 | 25, 32, 40 |

Pressure Pumps

Hero 75 / Hero 100



Water treatment is any process that improves the quality of water to make it more acceptable for a specific end-use. The end use may be drinking, industrial water supply, irrigation, river flow maintenance, water recreation or many other uses, including being safely returned to the environment.

There are various types of swimming pools. Swimming pools differ in function different size and conditions such as water temperature, cleaning system and water disinfection mechanism. A division can be made in indoor and outdoor swimming pools.

Swimming pool water must undergo treatment, in order to remain clear and clean, free from harmful substances, bacteria, viruses, algae and other pathogens and suitable for use by swimmers.

Features

- S.S. Impellers & diffuses in Hero 75, Hero 100 models for long life, smooth & noiseless operation.
- Available in fixed member pressure tank for long life. Also available in replaceable membrane tanks.

TECHNICAL DATA

| Brand | Model | HP | Size (in mm) | Voltage | Bathrooms |
|-------|----------|-----|--------------|-------------|-----------|
| kops | Hero 75 | 1.0 | 25 x 25 | 230 V/50 Hz | 1-4 |
| | Hero 100 | 1.5 | 32 x 25 | 230 V/50 Hz | 1-7 |

Flow Chart of KOPS Pressure Pumps

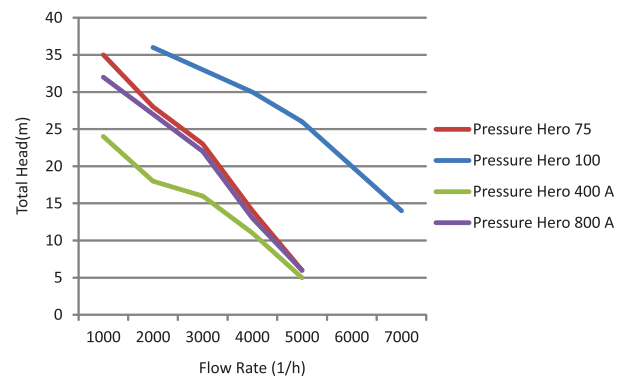

Hero 400 A / Hero 800 A



Features

- Compact Design, Multistage & Low Noise Pump.
- Constant Pressure. Best for Households.
- Built - in Pressure Tank, Switch & Flow Sensor.
- Pump will turn off Automatically in 60 seconds if there is no water.

TECHNICAL DATA

| Brand | Model | HP | Size (in mm) | Voltage | Bathrooms |
|-------|------------|------|--------------|-------------|-----------|
| kops | Hero 400 A | 0.5 | 25 x 25 | 230 V/50 Hz | 1-2 |
| | Hero 800 A | 0.75 | 25 x 25 | 230 V/50 Hz | 1-4 |



Water treatment is any process that improves the quality of water to make it more acceptable for a specific end-use. The end use may be drinking, industrial water supply, irrigation, river flow maintenance, water recreation or many other uses, including being safely returned to the environment.

There are various types of swimming pools. Swimming pools differ in function different size and conditions such as water temperature, cleaning system and water disinfection mechanism. A division can be made in indoor and outdoor swimming pools. Swimming pool water must undergo treatment, in order to remain clear and clean, free from harmful substances, bacteria, viruses, algae and other pathogens and suitable for use by swimmers.

Water supplied to domestic properties may be further treated before use, often using an in-line treatment process. Such treatments can include water softening or ion exchange. Many proprietary systems also claim to remove residual disinfectants and heavy metal ions.

MILD STEEL & FRP SOFTNERS (Brand - Kops)

| Model | SF - 80 | SF - 100 | SF - 150 | SF - 200 | SF - 250 | SF-300 |
|--------------------------------------|------------------------|-------------------------|-------------------------|-------------------------|-------------------------|-------------------------|
| Resin qty. | 80 lit. | 100 lit. | 150 lit. | 200 lit. | 250 lit. | 300 lit. |
| Output of soft water @ 250 ppm | 16000 lit. | 22000 lit. | 32000 lit. | 44000 lit. | 54000 lit. | 70000 lit. |
| Min. Working Pressure | 1.5 kg/cm ² | 1.5 kg/cm ² | 1.5 kg/cm ² | 1.5 kg/cm ² | 1.5 kg/cm ² | 1.5 kg/cm ² |
| Max Working Pressure | 3.5 kg/cm ² | 3.5 kg/cm ² | 3.5 kg/cm ² | 3.5 kg/cm ² | 3.5 kg/cm ² | 3.5 kg/cm ² |
| Size & Type of valve | Multiport valves | Souder Multiport valves | Souder Multiport valves | Souder Multiport valves | Souder Multiport valves | Souder Multiport valves |
| Qty. Of NaCl Salt req./ Regeneration | 11kg | 15kg | 23kg | 30kg | 38kg | 45kg |
| Vessel | FRP | M.S. / FRP | M.S. | M.S. | M.S. | M.S. |
| Max. Flow rate | 3.0 m ³ /hr | 4.0 m ³ /hr | 6.0 m ³ /hr | 8.0 m ³ /hr | 10.0 m ³ /hr | 12.0 m ³ /hr |



Domestic



Commercial

DESIGNER Water Fountains



Hydro Plus has been in the business of designing and building water-features since 2010. From simple aesthetically designed static water-features and swimming pools to the latest in computer controlled and musical show fountains with coordinated lighting, the Hydro Plus team is equipped to create a masterpiece in any shape or size, and in the shortest timeline. The range of equipment's manufactured by Hydro Plus is the result of years of research and development in the field of Hydraulics, Lighting and Control equipment. With over 10 years in this business Hydro Plus has in its folds some of the best brains in the water feature industry ensuring its customers complete peace of mind, be it Design Consulting or Turnkey Execution. An company with its manufacturing base in Delhi Hydro Plus is able to cater to a vast community of Architects, Consultants and Clients through its over 52 strong highly trained and experienced workforce.



Description - Finger jet nozzles produce a series of clear stream jets radiating outwards. Can be installed vertically or at an angle using two 90-degree bends.

Sizes - Available with 19mm and 25mm inlets.

MOC - Casting body with brass or S. Steel jets.

Custom - The no of outlets on the jet can be customized.

Type - Water level independent (no change in water effect with varying water level)

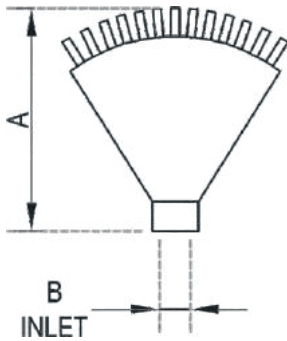

Dimensions

| MODEL | A | Inlet (B) |
|-----------------|-------|-----------|
| Finger Jet - 19 | 160mm | 19mm |
| Finger Jet - 25 | 160mm | 25mm |



Flow Rate for Finger Jet

| MODEL | | Finger Jet - 19 | Finger Jet - 25 |
|-----------------|-------------------|-----------------|-----------------|
| Spray Ht.(in m) | Spray Width(in m) | LPM | LPM |
| 1.00 | 5.00 | 44 | 52 |
| 1.20 | 6.00 | 47 | 56 |
| 1.50 | 7.00 | 50 | 59 |
| 1.80 | 8.00 | 53 | 62 |

Crown Nozzle



Description - Produces a single direction adjustable clear stream jet, suitable only for low jet heights and small bore sizes. Used mostly in groups on a ring of various diameters.

Sizes - Available with a 12mm inlet and bore sizes varying from 4mm to 10mm.

MOC - Casting body with brass or S. Steel jets.

Custom - Custom thread and bore sizes are possible for large qty.

Type - Water level independent (no change in water effect with varying water level)

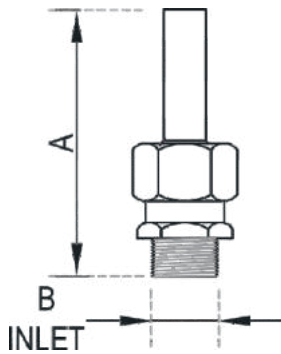

Dimensions

| MODEL | A | Inlet (B) |
|-------------------|------|-----------|
| Crown Nozzle 4mm | 60mm | 12mm |
| Crown Nozzle 6mm | 70mm | 12mm |
| Crown Nozzle 8mm | 75mm | 12mm |
| Crown Nozzle 10mm | 75mm | 12mm |

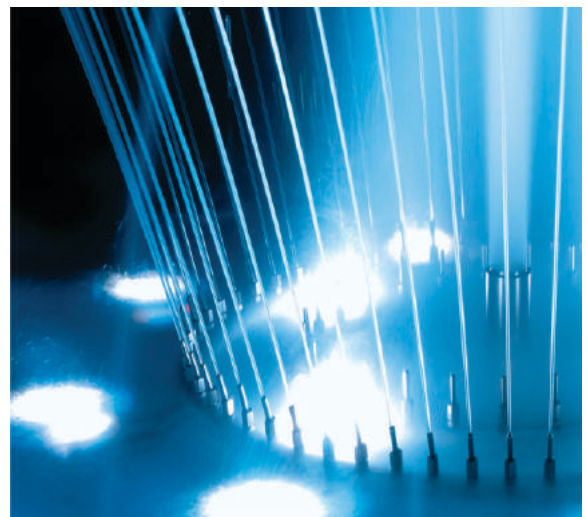

Flow Rate for Crown Nozzle

| MODEL | Crown Nozzle 4 | Crown Nozzle 6 | Crown Nozzle 8 | Crown Nozzle 10 |
|------------------|----------------|----------------|----------------|-----------------|
| Spray Ht. (in m) | LPM | LPM | LPM | LPM |
| 1.00 | 4 | 8 | 14 | 21 |
| 1.50 | 5 | 9 | 16 | 26 |
| 2.00 | 6 | 11 | 19 | 30 |
| 3.00 | 7 | 13 | 24 | 36 |

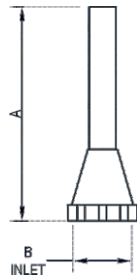

Dimensions

| MODEL | A | Inlet (B) |
|---------------------|-------|-----------|
| Hollow Jet (40/20) | 250mm | 40mm |
| Hollow Jet (50/25) | 300mm | 50mm |
| Hollow Jet (75/50) | 305mm | 75mm |
| Hollow Jet (100/75) | 470mm | 100mm |

Description - Hollow jet produces a single clear stream jet except that unlike the Vertical jet the jet of water produced by this jet is not solid due to the design of the jet. This helps reduce the overall pumping capacity required to produce the desired effect. This jet is only used for bore sizes in excess of 20mm.

Sizes - Available with 40mm to 100mm inlet sizes and varying bore sizes.

MOC - Casting body with brass or S. Steel jets.

Custom - Custom bore sizes are possible.

Type - Water level independent (no change in water effect with varying water level)



Flow Rate for Hollow Jet Nozzle

| MODEL | Hollow Jet (40/20) | Hollow Jet (50/25) | Hollow Jet (75/50) | Hollow Jet (100/75) |
|------------------|--------------------|--------------------|--------------------|---------------------|
| Spray Ht. (in m) | LPM | LPM | LPM | LPM |
| 3.00 | 116 | 145 | | |
| 4.00 | 133 | 167 | | |
| 6.00 | 163 | 205 | 406 | |
| 8.00 | 188 | 236 | 472 | |
| 10.00 | | 264 | 528 | |
| 12.00 | | | 578 | |
| 15.00 | | | 647 | 970 |
| 18.00 | | | 708 | 1062 |
| 20.00 | | | 746 | 1084 |
| 25.00 | | | | 1252 |
| 30.00 | | | | 1371 |
| 40.00 | | | | 1583 |
| 50.00 | | | | 1770 |

Lily Nozzle

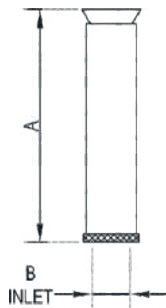

Description- Produces a clear sheet of water similar to the bell nozzle but in a flat cone shape. Dia of the cone can be adjusted by turning the top of the nozzle clockwise or anticlockwise.

Sizes - Available from 25mm to 50mm inlet sizes and 200mm to 300mm length with pipe dia varying from 50mm to 75mm.

MOC - Casting body with brass or S. Steel jets.

Custom - Custom nozzle heights are possible.

Type - Water level independent (no change in water effect with varying water level)



Dimensions

| MODEL | A | Inlet (B) |
|----------------|-------|-----------|
| Lily 25/50/200 | 200mm | 25mm |
| Lily 25/50/250 | 250mm | 25mm |
| Lily 40/75/250 | 250mm | 40mm |
| Lily 50/75/300 | 300mm | 50mm |

Flow Rate for Lily Nozzle

| MODEL | Lily 25/50/200 | Lily 25/50/250 | Lily 40/75/250 | Lily 50/75/300 |
|-------------------|----------------|----------------|----------------|----------------|
| Spread dia (in m) | LPM | LPM | LPM | LPM |
| 1.00 | 24 | | | |
| 1.50 | 29 | 29 | | |
| 2.00 | 33 | 33 | 58 | 121 |
| 3.00 | 41 | 41 | 72 | 147 |
| 4.00 | 47 | 47 | 83 | 170 |
| 6.00 | 57 | 57 | 102 | 208 |
| 8.00 | | | 117 | 240 |
| 10.00 | | | 131 | 268 |
| 12.00 | | | 160 | 294 |

Vertical Jet

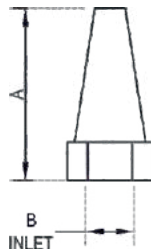

Dimensions

| MODEL | A | INLET (B) | OUTLET |
|--------------------|-------|-----------|--------|
| Vertical Jet - 20 | 80mm | 20mm | 10mm |
| Vertical Jet - 25 | 100mm | 25mm | 13mm |
| Vertical Jet - 40 | 150mm | 40mm | 20mm |
| Vertical Jet - 50 | 205mm | 50mm | 25mm |
| Vertical Jet - 65 | 205mm | 65mm | 32mm |
| Vertical Jet - 75 | 225mm | 75mm | 37mm |
| Vertical Jet - 100 | 275mm | 100mm | 50mm |

Description - Smooth bore single clear stream jet with fixed direction, should be installed with an additional universal joint in case directional adjustment is required. Can be installed vertically or at an angle using two 90-degree bends.

Sizes - Available from 20mm to 100mm inlets with varying bore sizes

MOC - Casting body with brass or S. Steel jets.

Custom - Custom bore sizes and inlets are possible.

Type - Water level independent (no change in water effect with varying water level)



Flow Rate for Vertical Jet Nozzle

| MODEL | Vertical Jet-20 | Vertical Jet-25 | Vertical Jet- 40 | Vertical Jet- 50 | Vertical Jet - 65 | Vertical Jet -75 | Vertical Jet -100 |
|------------------|-----------------|-----------------|------------------|------------------|-------------------|------------------|-------------------|
| Spray Ht. (in m) | LPM | LPM | LPM | LPM | LPM | LPM | LPM |
| 1.00 | 21 | 36 | 77 | | | | |
| 1.50 | 26 | 44 | 98 | | | | |
| 2.00 | 30 | 50 | 106 | 185 | 303 | 404 | 738 |
| 3.00 | 36 | 62 | 130 | 226 | 371 | 495 | 904 |
| 4.00 | 42 | 71 | 150 | 261 | 427 | 571 | 1043 |
| 6.00 | 51 | 87 | 185 | 320 | 524 | 700 | 1277 |
| 8.00 | | | 213 | 369 | 604 | 808 | 1475 |
| 10.00 | | | 238 | 412 | 675 | 904 | 1649 |
| 12.00 | | | | 452 | 740 | 990 | 1806 |
| 15.00 | | | | 506 | 827 | 1106 | 2020 |
| 18.00 | | | | 554 | 906 | 1212 | 2212 |
| 20.00 | | | | 584 | 955 | 1277 | 2332 |
| 25.00 | | | | 652 | 1068 | 1428 | 2608 |
| 30.00 | | | | 715 | 1170 | 1564 | 2856 |
| 40.00 | | | | 825 | 1351 | 1806 | 3298 |
| 50.00 | | | | 922 | 1510 | 2020 | 3688 |

3 Stage Jet

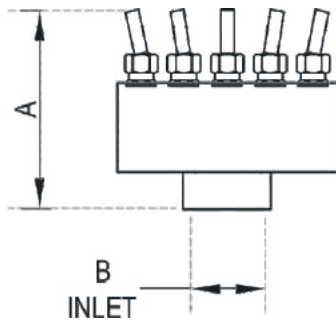
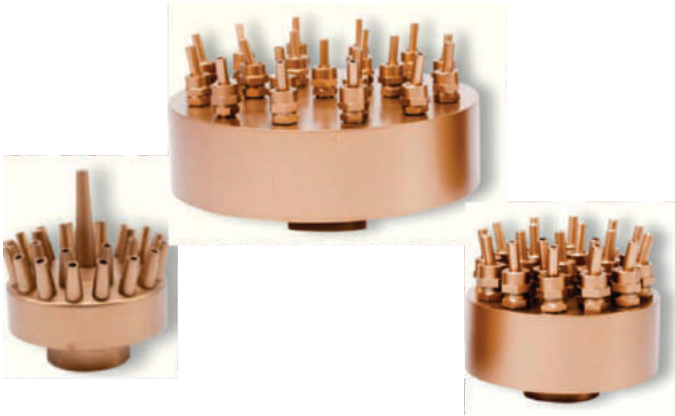

Dimensions

| MODEL | A | Inlet (B) |
|----------------------|-------|-----------|
| 3 Stage Jet 3/19/25 | 130mm | 25mm |
| 3 Stage Jet 3/25a/25 | 130mm | 25mm |
| 3 Stage Jet 3/19a/50 | 130mm | 50mm |

Description - Multiple fine streams creating a 3-tiered water effect.

Sizes - Available in 25mm and 50mm inlets with fixed and adjustable nozzles.

MOC - Casting body with brass or S. Steel jets.

Custom - Can be customized for various stream sizes.

Type - Water level independent (no change in water effect with varying water level)

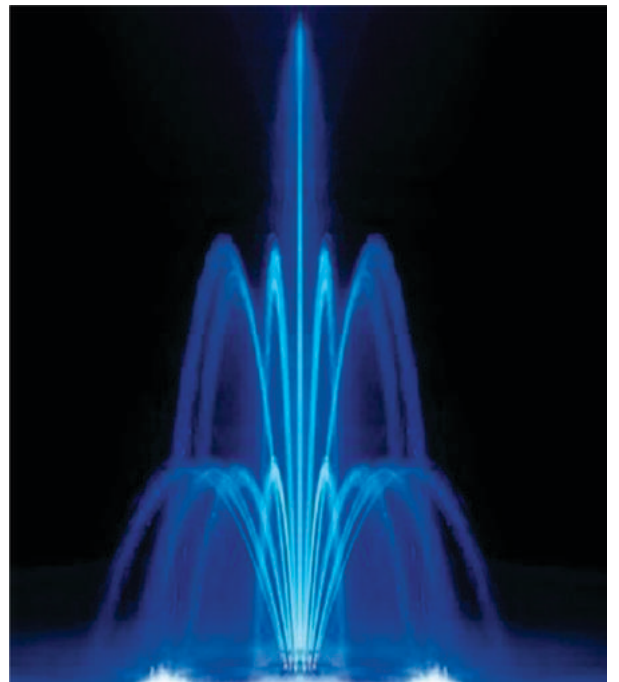

Flow Rate for 3 Stage Jet

| MODEL | 3 Stage Jet 3/19/25 | 3 Stage Jet 3/25a/25 | 3 Stage Jet 3/19a/50 |
|-----------------|---------------------|----------------------|----------------------|
| Spray Ht.(in m) | LPM | LPM | LPM |
| 0.50 | 46 | 60 | |
| 1.00 | 65 | 85 | 143 |
| 1.50 | 78 | 103 | 175 |
| 1.80 | 86 | 113 | 193 |
| 2.00 | 90 | 118 | 202 |

Vertical Jet AF

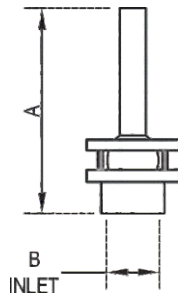

Dimensions

| MODEL | A | Inlet (B) | Outlet |
|-------------------------|-------|-----------|--------|
| Vertical Jet (AF-12-6) | 80mm | 12mm | 6mm |
| Vertical Jet (AF-20-8) | 80mm | 20mm | 8mm |
| Vertical Jet (AF-20-10) | 80mm | 20mm | 10mm |
| Vertical Jet (AF-25-12) | 170mm | 25mm | 12.7mm |
| Vertical Jet (AF-40-16) | 180mm | 40mm | 16mm |
| Vertical Jet (AF-40-19) | 180mm | 40mm | 19mm |
| Vertical Jet (AF-50-25) | 180mm | 50mm | 25mm |

Description - Smooth bore single clear stream jet with adjustable direction. Normally used in groups to form a circle or straight line of jets.

Sizes - Available from 12mm to 50mm inlet sizes with a variety of bore sizes.

MOC - Casting body with brass or S. Steel jets.

Custom - Custom inlets, or threads are possible.

Type - Water level independent (no change in water effect with varying water level)



Flow Rate for Vertical Jet AF Nozzle

| MODEL | Vertical Jet (AF-12-6) | Vertical Jet (AF-20-8) | Vertical Jet (AF-20-10) | Vertical Jet (AF-25-12) | Vertical Jet (AF-40-16) | Vertical Jet (AF-40-19) | Vertical Jet (AF-50-25) |
|------------------|------------------------|------------------------|-------------------------|-------------------------|-------------------------|-------------------------|-------------------------|
| Spray Ht. (in m) | LPM | LPM | LPM | LPM | LPM | LPM | LPM |
| 1.00 | 10 | 14 | 21 | 35 | 54 | 77 | |
| 1.50 | 11 | 16 | 26 | 43 | 66 | 98 | |
| 2.00 | 12 | 19 | 30 | 48 | 76 | 106 | 185 |
| 3.00 | 13 | 24 | 36 | 59 | 92 | 130 | 226 |
| 4.00 | 14 | 27 | 42 | 68 | 106 | 150 | 261 |
| 6.00 | | | 51 | 83 | 130 | 185 | 320 |
| 8.00 | | | | | 151 | 213 | 369 |
| 10.00 | | | | | 169 | 238 | 412 |
| 12.00 | | | | | | 452 | |
| 15.00 | | | | | | 506 | |
| 18.00 | | | | | | 554 | |
| 20.00 | | | | | | 584 | |
| 25.00 | | | | | | 652 | |
| 30.00 | | | | | | 715 | |
| 40.00 | | | | | | 825 | |
| 50.00 | | | | | | 922 | |

Crown Ring

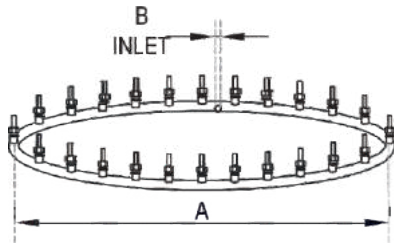

Description - The crown rings produce a fine circular water pattern using multiple clear stream nozzles mounted on a single ring. The direction adjustment of the nozzles can create various effects such as inward crown, outward crown, vertical crown, inward weave or outward weave.

Sizes - Crown rings are available in a wide variety of ring diameters and pipe sizes with a variety of inlets sizes.

MOC - GI / SS Pipe ring with Machined Brass nozzles

Custom - Crown rings can be customized for various ring diameters and nozzle bore sizes.

Type - To be installed in a way that the ring is either embedded in the civil structure or is below the water and only the individual nozzles are visible above the water.

Dimensions

| MODEL | A | Inlet (B) | No. of Nozzles |
|-----------------------|-----------|-----------|----------------|
| Crown Ring 1.25/24/25 | 1.25m dia | 2x25mm | 24 |
| Crown Ring 2/36/25 | 2.0m dia | 2x25mm | 36 |
| Crown Ring 3/65/40 | 3.0m dia | 2x40mm | 65 |
| Crown Ring 4/75/40 | 4.0m dia | 2x40mm | 75 |
| Crown Ring 5/95/50 | 5.0m dia | 2x50mm | 95 |
| Crown Ring 6/115/50 | 6.0m dia | 2x50mm | 115 |
| Crown Ring 7/130/50 | 7.0m dia | 2x50mm | 130 |



Flow Rate for Crown Ring

| MODEL | LPM |
|-----------------------|------|
| Crown Ring 1.25/24/25 | 127 |
| Crown Ring 2/36/25 | 270 |
| Crown Ring 3/65/40 | 598 |
| Crown Ring 4/75/40 | 795 |
| Crown Ring 5/95/50 | 1131 |
| Crown Ring 6/115/50 | 1495 |
| Crown Ring 7/130/50 | 1833 |

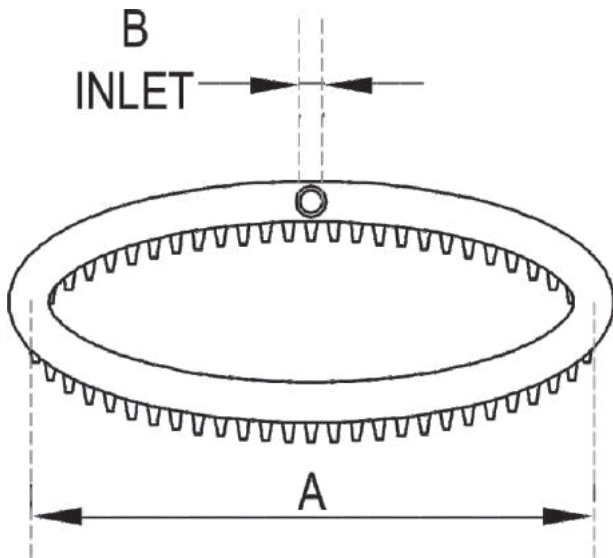

Description - Same as the water curtain except the water falls free and not along strings. Needs a larger basin due to the splash created by the free falling water. High level of sound created by the falling water.

Sizes - Available in a wide variety of ring diameters.

MOC - GI / SS pipe ring with Machined brass nozzles.

Custom - Rain Curtains can be customized for various sizes (circular or straight line) and number of nozzles.

Type - Installed in a way that the water flows down free from the ring to the pool.

Dimensions

| MODEL | A | Inlet (B) |
|-----------------------|-----------|-----------|
| R. C. Ring 450/56/25 | 0.45m dia | 25mm |
| R. C. Ring 600/75/25 | 0.6m dia | 25mm |
| R. C. Ring 900/113/25 | 0.9m dia | 25mm |

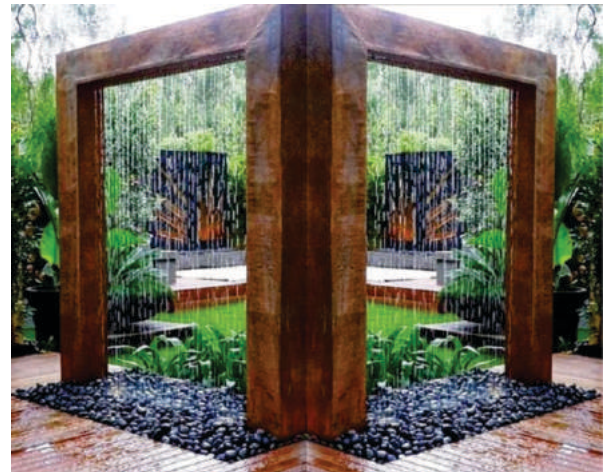

Flow Rate for Rain Curtain

| MODEL | W. C. Ring 450/56/25 | W. C. Ring 600/75/25 | W. C. Ring 900/113/25 |
|-----------------|----------------------|----------------------|-----------------------|
| Fall Ht. (in m) | LPM | LPM | LPM |
| 3.00 | 68 | 90 | 136 |

Jumping Jet (with LED light)

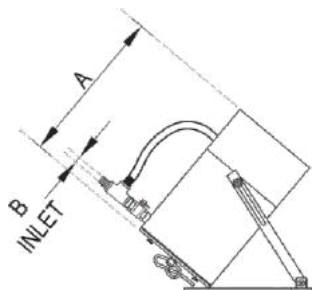

Description- Produces a clear laminar stream of water, which can be 'cut' into streams of various sizes using a cutting mechanism and creating the effect of a jumping rod or blob of water which visibly feels like its jumping from one point to the other. The length of the rod and the distance of the jump can be controlled. The internally placed LED light creates a highly attractive effect at night. Can produce a very interesting water pattern when installed in multiples of 4 or more.

Sizes - Available in 10mm bore size with a max throw of 2.5m length by 1.25m height

MOC - Casting body with brass or S. Steel jets.

Custom - All Programmable water features are custom designed.

Type - To be installed in a specially designed pit with water level below the nozzle.

Dimensions

| MODEL | A | Inlet (B) |
|--|-------|-----------|
| Jumping Jet with built in LED Light 3W | 400mm | 20mm |

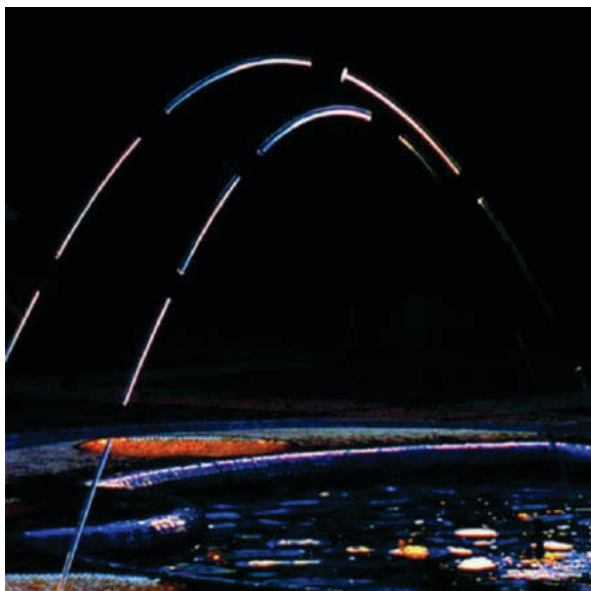

Flow Rate for Jumping Jet Nozzle

| MODEL | Jumping Jet Nozzle | |
|----------------|--------------------|-----|
| Max. Ht.(in m) | Max. Throw(in m) | LPM |
| 0.50 | 1.00 | 40 |
| 0.75 | 1.50 | 48 |
| 1.00 | 2.00 | 56 |
| 1.25 | 2.50 | 60 |

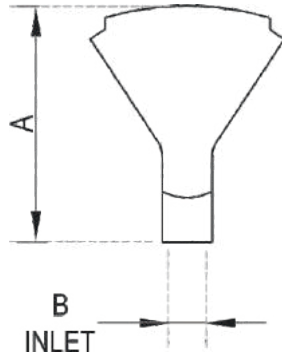

- Description - Produces a fan shaped sheet of water when installed at a 45 degree angle.
- Sizes - Available with 25mm and 40mm inlet Sizes.
- MOC - Casting body with brass or S. Steel jets.
- Custom - The width of the fan shaped water effect can be customized.
- Type - Water level independent (no change in water effect with varying water level)

Dimensions

| MODEL | A | Inlet (B) |
|-------------|-------|-----------|
| Fan Jet- 25 | 190mm | 25mm |
| Fan Jet- 40 | 190mm | 40mm |



Flow Rate for Fan Jet (Performances at 45°)

| MODEL | | Fan Jet -25 | Fan Jet -40 |
|-----------------|-------------------|-------------|-------------|
| Spray Ht.(in m) | Spray Throw(in m) | LPM | LPM |
| 0.50 | 2.00 | 75 | 98 |
| 1.00 | 4.00 | 108 | 114 |
| 1.50 | 6.00 | 132 | 147 |
| 2.00 | 7.50 | 150 | 164 |
| 3.00 | 9.00 | | 197 |

Flower Jet

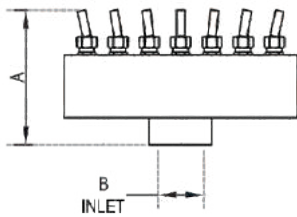

Description - Produces a single ring of fine jets of water flowing outwards from a central nozzle.

Sizes - Available from 25mm to 50mm inlets with no of outlets varying from 12 to 36

MOC - Casting body with brass or S. Steel jets.

Custom - No of outlets on the nozzle can be customized.

Type - Water level independent (no change in water effect with varying water level)

Dimensions

| MODEL | A | Inlet (B) |
|------------------|-------|-----------|
| Flower Jet 25/12 | 140mm | 25mm |
| Flower Jet 32/24 | 140mm | 32mm |
| Flower Jet 50/36 | 140mm | 50mm |



Flow Rate for Flower Jet

| MODEL | Flower Jet 25/12 | Flower Jet 32/24 | Flower Jet 50/36 |
|------------------|------------------|------------------|------------------|
| Spray Ht. (in m) | LPM | LPM | LPM |
| 1.00 | 48 | 96 | 144 |
| 1.50 | 54 | 108 | 162 |
| 2.00 | 60 | 120 | 180 |
| 3.00 | 72 | 144 | 216 |
| 4.00 | 84 | 168 | 252 |
| 6.00 | 108 | 216 | 324 |

Geyser Jet



Description- One of the most widely used nozzle, produces a thick foaming mass of water suitable for small and medium jet heights.

Sizes - Available from 20mm to 50mm inlet sizes with a variety of construction materials.

MOC - Casting body with brass or S. Steel jets.

Custom - Custom bore sizes are possible.

Type - Water level dependent (Water effect changes with change in water level over the nozzle outlet.)

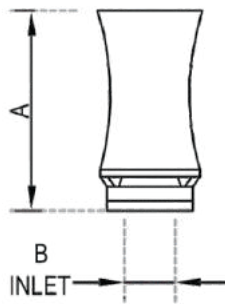

Dimensions

| MODEL | A | Inlet (B) |
|-------------------|-------|-----------|
| Geyser Jet 20/80 | 80mm | 20mm |
| Geyser Jet 19/130 | 130mm | 19mm |
| Geyser Jet 25/135 | 135mm | 25mm |
| Geyser Jet 40/190 | 190mm | 40mm |
| Geyser Jet 50/300 | 300mm | 50mm |



Flow Rate for Geyser Jet Nozzle

| MODEL | Geyser Jet 20/80 | Geyser Jet 19/130 | Geyser Jet 25/135 | Geyser Jet 40/190 | Geyser Jet 50/300 |
|------------------|------------------|-------------------|-------------------|-------------------|-------------------|
| Spray Ht. (in m) | LPM | LPM | LPM | LPM | LPM |
| 0.15 | 21 | | | | |
| 0.30 | 30 | | | | |
| 0.50 | 36 | 45 | 75 | 95 | |
| 1.00 | 51 | 63 | 108 | 108 | |
| 1.20 | | 69 | 117 | 126 | |
| 1.50 | | 78 | 132 | 144 | 280 |
| 2.00 | | | 150 | 162 | 324 |
| 2.50 | | | | 180 | 362 |
| 3.00 | | | | | 396 |

Water Sheet

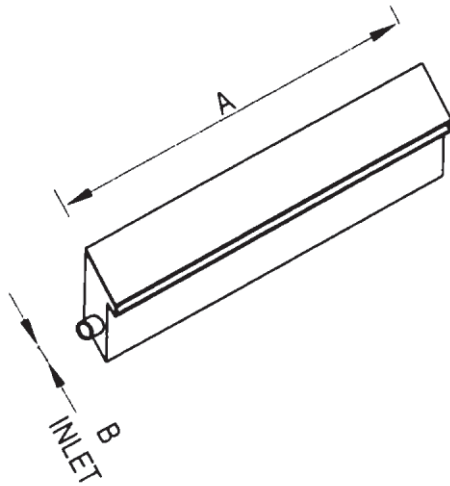

Description - Produces a clear unbroken sheet of water when installed at the prescribed height. The nozzle is designed to create a smooth untroubled flow of water from the lip of the nozzle. Care is not be taken to side the pump correctly to get the correct results. The sound effect of this nozzle can be very high so care needs to be taken while choosing this for areas where low sound effects are desired.

Sizes - Available in 1m and 1.5 m width.

MOC - SS Frame.

Custom - Can be customized for different widths but not exceeding 1.5m inlet location and size can also be customized

Type - The nozzle is installed inside the wall at the prescribed height with the lip at least 25mm out of the wall.

Dimensions

| MODEL | A | Inlet (B) |
|------------------|------|-----------|
| Water Sheet 1000 | 1.0m | 1 x 40mm |
| Water Sheet 1500 | 1.5m | 2 x 40mm |

Flow Rate For Water Sheet

| MODEL | WATER SHEET 1000 | WATER SHEET 1500 |
|------------------|------------------|------------------|
| Spray Ht. (in m) | LPM | LPM |
| 0.50 | 66 | 100 |
| 1.00 | 150 | 225 |
| 1.50 | 250 | 375 |
| 2.00 | 580 | 870 |
| 3.00 | 1050 | 1575 |



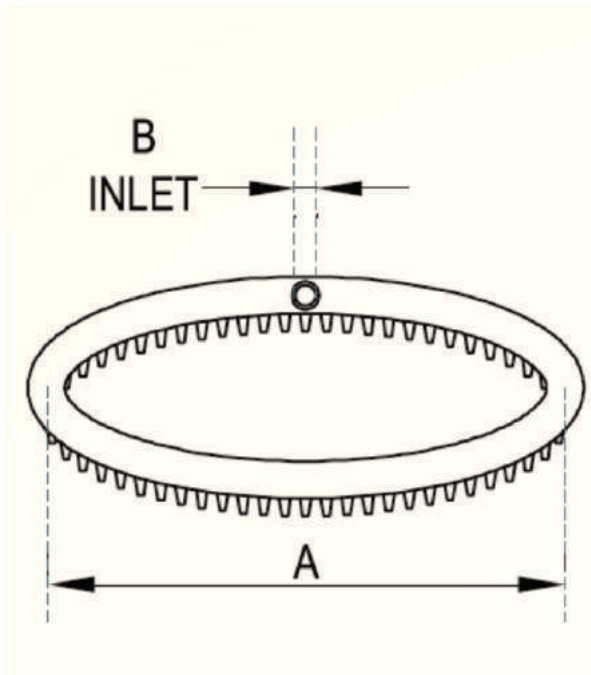

Description - Creates a curtain of water flowing down fine nylon threads, can be designed for various height and curtain diameters. One of the most elegant water-features for an indoor space with any height. Ideal since water flowing down the string does not need a large basin at the bottom due to an almost negligible splash. Due to the water flowing along the threads the sound level is very low even for very high water effects.

- Size** - Available in a wide variety of sizes.
- MOC** - GI / SS pipe with machined brass nozzles.
- Custom** - Water curtains can be customized for various sizes & no. of nozzles.
- Type** - Installed in a way that the water flows down from the ring to the pool along the strings.

Dimensions

| MODEL | A | Inlet (B) | No. Of Nozzle |
|-----------------------|-----------|-----------|---------------|
| W. C. Ring 450/56/25 | 0.45m dia | 25mm | 56 |
| W. C. Ring 600/75/25 | 0.6m dia | 25mm | 75 |
| W. C. Ring 900/113/25 | 0.9m dia | 25mm | 113 |



Flow Rate for Water Curtain

| MODEL | W. C. Ring 450/56/25 | W. C. Ring 600/75/25 | W. C. Ring 900/113/25 |
|-----------------|----------------------|----------------------|-----------------------|
| Fall Ht. (in m) | LPM | LPM | LPM |
| 3.00 | 62 | 83 | 125 |

Bell Nozzle

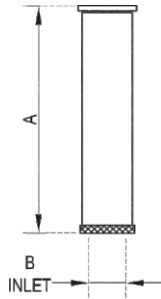

Description - Produces a clear sheet of water falling in the form of an umbrella. Dia of the umbrella can be adjusted by turning the top of the nozzle clockwise or anticlockwise.

Sizes - Available with 25mm inlet and 300mm or 450mm length with 50mm pipe dia.

MOC - Casting body with brass or S. Steel jets.

Custom - Custom nozzle heights are possible.

Type - Water level independent (no change in water effect with varying water level)

Dimensions

| MODEL | A | Inlet (B) |
|----------------|-------|-----------|
| Bell 25/50/300 | 300mm | 25mm |
| Bell 25/50/450 | 450mm | 25mm |



Flow Rate for Bell Nozzle

| MODEL | Bell 25/50/300 | Bell 25/50/450 |
|------------------|----------------|----------------|
| Spray Ht. (in m) | LPM | LPM |
| 0.30 | 25 | 40 |
| 0.45 | 35 | 50 |

Column Jet



Description - Consists of a number of fine bore jets placed on a central manifold in a single or multiple circles to create a thick column of water.

Sizes - Available from 40mm to 100mm inlet sizes.

MOC - Casting body with brass or S. Steel jets.

Type - Water level independent (no change in water effect with varying water level)

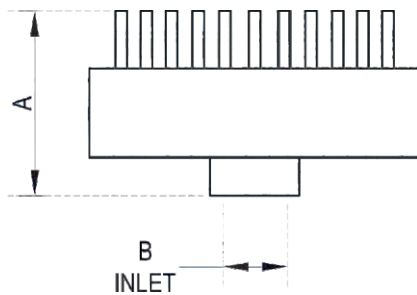

Dimensions

| MODEL | A | Inlet (B) |
|---------------------|-------|-----------|
| Column Jet 40/1/24 | 130mm | 40mm |
| Column Jet 50/1/36 | 130mm | 50mm |
| Column Jet 65/2/42 | 130mm | 65mm |
| Column Jet 100/2/48 | 130mm | 100mm |

Flow Rate for Column Jet

| MODEL | Column Jet 40/1/24 | Column Jet 50/1/36 | Column Jet 65/2/42 | Column Jet 100/2/48 |
|------------------|--------------------|--------------------|--------------------|---------------------|
| Spray Ht. (in m) | LPM | LPM | LPM | LPM |
| 1.00 | 96 | 144 | 168 | 192 |
| 2.00 | 120 | 180 | 210 | 240 |
| 3.00 | 144 | 216 | 252 | 288 |
| 4.00 | 168 | 252 | 294 | 336 |
| 6.00 | 216 | 324 | 378 | 432 |

Dandelion Nozzle



Description - This nozzle consists of a large no of independent nozzles mounted on top of a central cast Bronze ball. Depending upon the adjustment of the nozzle tips the effect can change from fine mist to a fine film of water creating a large ball of mist or bell effects that look very appealing especially when lit at night. The visibility of the ball with multiple arms when not in operation is a drawback of this nozzle and its use is preferred in public parks or play areas. This nozzle requires clean filtered water in the pool and a very fine mesh screen on the pump suction to keep the nozzles from getting blocked with debris.

Sizes - Available as a full ball of 1m to 3m or a Half ball of 1.5m to 2m

MO - Cast , Aluminum, Machined Brass. With brass chrome & SS finish on the ball and nozzle tips and powder coating on the Aluminum arms.

Custom - Length of arms can be customized to vary the overall ball size.

Type - Water level independent (no change in water effect with varying water level)

Flow Rate for Dandelion

| MODEL | LPM |
|-----------------------|------|
| Dandelion 3/71 | 1065 |
| Dandelion 2/71 | 1065 |
| Dandelion 1.5/71 | 1065 |
| Dandelion 1/35 | 525 |
| Half Dandelion 1.5/47 | 705 |
| Half Dandelion 2/47 | 705 |

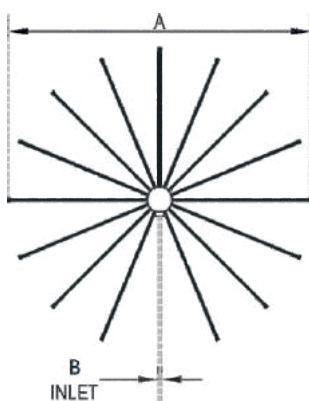

Dimensions

| MODEL | A | Inlet (B) | No. of Arms |
|-----------------------|------|-----------|-------------|
| Dandelion 3/71 | 3.0m | 65mm | 71 |
| Dandelion 2/71 | 2.0m | 65mm | 71 |
| Dandelion 1.5/71 | 1.5m | 65mm | 71 |
| Dandelion 1/35 | 1.0m | 50mm | 35 |
| Half Dandelion 1.5/47 | 1.5m | 50mm | 47 |
| Half Dandelion 2/47 | 2.0m | 50mm | 47 |

Foam Jet



- Description** - Produces a single stream of foaming water. The design creates a pressure drop inside the nozzle which sucks in air and mixes it with the water stream to create an impressive water effect.
- Sizes** - Available from 12mm to 50mm inlet sizes.
- MOC** - Casting body with brass or S. Steel jets.
- Type** - Water level independent (no change in water effect with varying water level)

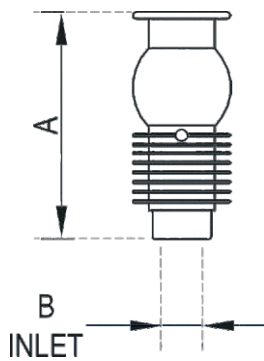

Dimensions

| MODEL | A | Inlet (B) |
|--------------|-------|-----------|
| Foam Jet -12 | 100mm | 12mm |
| Foam Jet -25 | 180mm | 25mm |
| Foam Jet -40 | 180mm | 40mm |
| Foam Jet -50 | 180mm | 50mm |

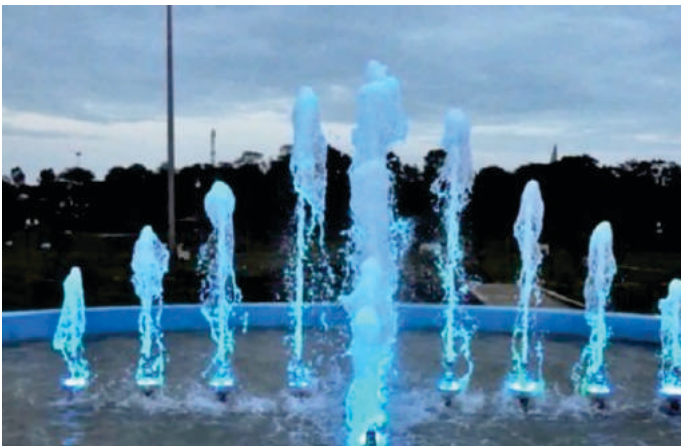

Flow Rate for Foam Jet

| MODEL | Foam Jet -12 | Foam Jet -25 | Foam Jet -40 | Foam Jet -50 |
|------------------|--------------|--------------|--------------|--------------|
| Spray Ht. (in m) | LPM | LPM | LPM | LPM |
| 0.30 | 19 | 27 | 102 | 115 |
| 0.50 | 24 | 35 | 117 | 149 |
| 1.00 | 34 | 58 | 132 | 210 |
| 1.50 | | 70 | 147 | 256 |
| 2.00 | | | 162 | 296 |

Laminar Jet (with LED Light)

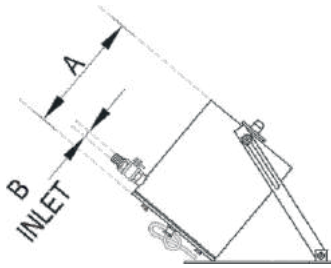

Description - Same as the jumping jet but without the cutting mechanism. Produces a clear laminar stream of water that resembles a glass rod when seen closely. The internally placed LED light creates a highly attractive effect at night.

Sizes - Available in 10mm bore size with a max throw of 2.5m length by 1.25m height

MOC - Casting body with brass or S. Steel jets.

Custom - All Programmable water features are custom designed.

Type - To be installed in a specially designed pit with water level below the nozzle.



Dimensions

| MODEL | A | Inlet (B) |
|--|-------|-----------|
| Laminar Jet with built in LED Light 3W | 300mm | 20mm |



Flow Rate for Laminar Jet Nozzle

| MODEL | Laminar Jet Nozzle | |
|-----------------|--------------------|-----|
| Spray Ht.(in m) | Max. Throw(in m) | LPM |
| 0.50 | 1.00 | 30 |
| 0.75 | 1.50 | 36 |
| 1.00 | 2.00 | 42 |
| 1.25 | 2.50 | 45 |

Revolving Jet Fountain



Description - The Revolving Jet is divided into two parts the lower revolving mechanism with 4 arms which uses water pressure to revolve the nozzle and the upper part which consists of the nozzle and can be either a single Crown nozzle / Vertical jet AF or a finger jet or 4 spiral arms, each type creating a different visual effect while revolving.

Sizes - Available with a 25mm or 50mm inlet and crown, finger or 4 spiral arms mounted on the revolving mechanism.

MOC - Casting body with brass or S. Steel jets.

Custom - Custom bore sizes for the nozzle are possible.

Type - Water level independent (no change in water effect with varying water level)

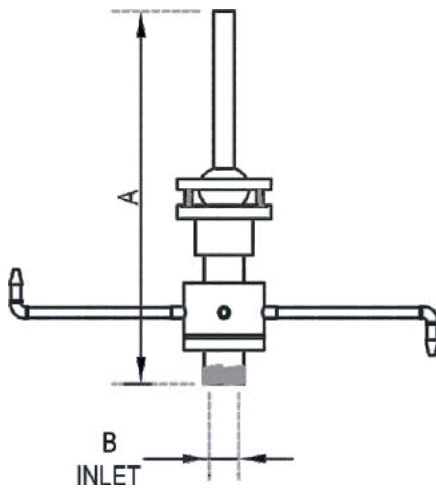

Dimensions

| MODEL | A | Inlet (B) |
|----------------------|-------|-----------|
| Revolving Crown Jet | 250mm | 25mm |
| Revolving Finger Jet | 250mm | 25mm |
| Revolving Spiral Jet | 250mm | 50mm |



Flow Rate for Revolving Jet

| MODEL | Revolving Crown Jet | Revolving Finger Jet | Revolving Spiral Jet |
|------------------|---------------------|----------------------|----------------------|
| Spray Ht. (in m) | LPM | LPM | LPM |
| 1.00 | | 80 | |
| 1.50 | | 87 | |
| 2.00 | | 93 | 148 |
| 3.00 | 87 | | 172 |
| 4.00 | 96 | | 196 |
| 6.00 | 111 | | 232 |

2 Stage Jet



Description - Multiple fine streams creating a 2-tiered water effect.

Sizes - Available in 25mm and 50mm inlets with fixed and adjustable nozzles.

MOC - Casting body with brass or S. Steel jets.

Custom - Can be customized for various stream sizes.

Type - Water level independent (no change in water effect with varying water level)

Dimensions

| MODEL | A | Inlet (B) |
|----------------------|-------|-----------|
| 2 Stage Jet 2/18/25 | 95mm | 25mm |
| 2 Stage Jet 2/18a/25 | 130mm | 25mm |

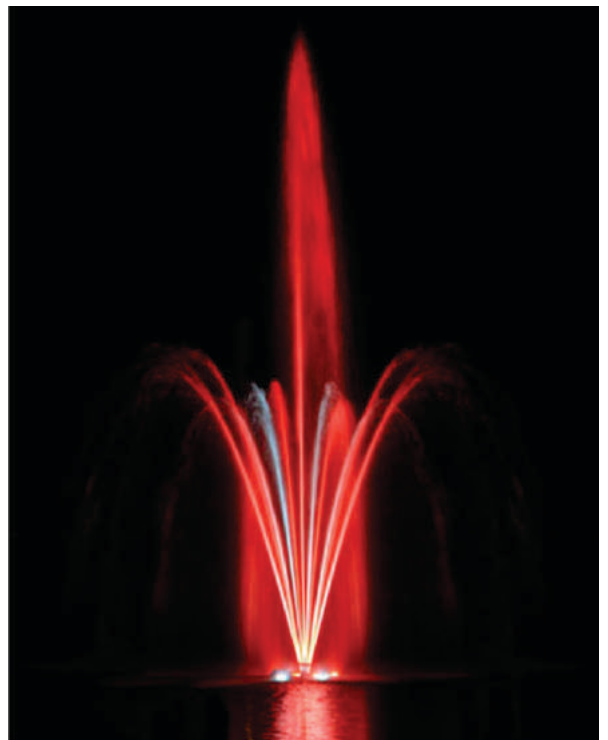
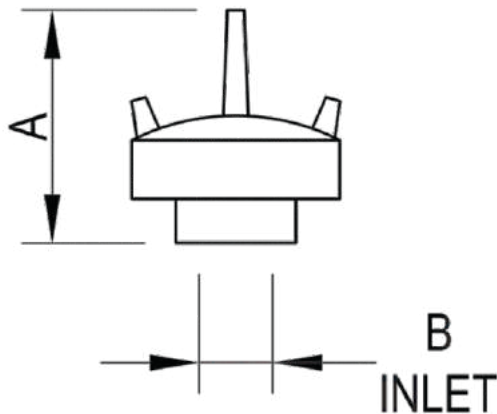

Flow Rate for 2 Stage Jet

| MODEL | 2 Stage Jet 2/18/25 | 2 Stage Jet 2/18a/25 |
|------------------|---------------------|----------------------|
| Spray Ht. (in m) | LPM | LPM |
| 0.50 | 44 | 44 |
| 1.00 | 62 | 62 |
| 1.50 | 74 | 74 |
| 1.80 | 82 | 82 |
| 2.00 | 86 | 86 |

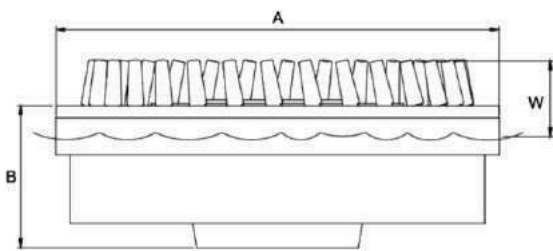

Simple fountain nozzle comprised of a set of 4mm water jets arranged in such a way that on rising they look like diamonds and falling like the stars.

The angle given to the jets means that, from wherever they are positioned, spectators can see the front & back jet cross over producing an aesthetics effect of great beauty in the architectural fountain. The range is comprised of three sizes with 15, 20 & 30 fountain jets.

SPECIFICATION DATA :

Construction shall be cast bronze with precision clear stream brass nozzle neoprene gasket and stainless steel fasteners.

MOC : Casting body with brass or S. Steel jets.



Dimensions

| Model | (A) | (B) | (W) |
|------------------------|-----|-----|-----|
| Diamond Jet (1inch) | 140 | 100 | 40 |
| Diamond Jet (1.5 inch) | 203 | 103 | 45 |
| Diamond Jet (2.5 inch) | 254 | 113 | 50 |

Flow Rate For Diamond Jet

| Model | Diamond Jet (1 inch 15 Jet) | Diamond Jet (1.5 inch 20 jet) | Diamond Jet (2.5 inch 30 jet) |
|------------------|-----------------------------|-------------------------------|-------------------------------|
| Spray Ht. (in m) | LPM | LPM | LPM |
| 0.50 | 52 | 70 | |
| 1.00 | 100 | 138 | 207 |
| 1.50 | | 166 | 250 |
| 2.00 | | 188 | 282 |
| 2.50 | | | 300 |
| 3.00 | | | 330 |

Cluster Jet

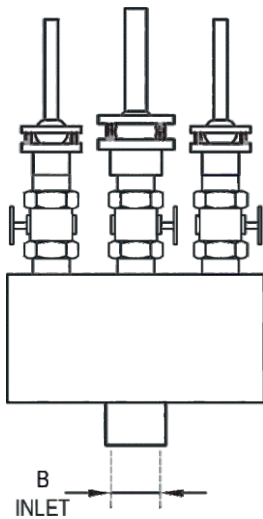

Dimensions

| MODEL | Inlet (B) |
|--|-----------|
| 2 Ring Cluster cascade 50/6 (1/40+5/25) | 50mm |
| Ring Cluster cascade 100/6 (1/50+5/40) | 100mm |

Description- Consists of multiple clear stream jets (Vertical Jet AF) installed on a single manifold to create a large volume of visible water in the air. Ideal for floating fountains or large pools designed for high visibility.

Sizes - Available with 50mm and 100mm inlets and various combinations of nozzles.

MOC - Casting body with brass or S. Steel jets.

Custom - Can be customized using a variety of nozzles on the manifold.

Type - Water level independent (no change in water effect with varying water level)



Flow Rate for cluster Cascade Jet Nozzlet

| MODEL | Cluster cascade 50/6 | Cluster Cascade 100/6 |
|------------------|----------------------|-----------------------|
| Spray Ht. (in m) | LPM | LPM |
| 6.0m - 3.0m | 500 | 1045 |
| 8.0m - 4.0m | 577 | 1204 |
| 10.0m - 5.0m | 644 | 1348 |
| 12.0m - 6.0m | 705 | 1477 |

Extraordinary Experience For Guests
Incredible Opportunities For Hoteliers



Welcome to a Smart Hotel. A hotel that delivers unique experiences for guests and staff. Where service meets sustainability. And where comfort, quality, and luxury are never compromised. Through one interface—whether it's a remote, touch screen or a keypad on the wall—guests can control drapes, lights, temperature, TV, and music, schedule wake-up scenes, request valet service, and more. The Hydro Plus Hospitality Solution works with both retrofit and new construction hotels to transform the guest experience and enhance hotel operational efficiency, creating a win for the property manager and a very special stay for the traveler. We know you already have products and systems that you rely on to provide top-notch service to your guests, that's why interoperability is key. Hydro Plus integrates with the brands built for hospitality—the brands you trust. Better still, our solution is affordable and everything is 100% scalable, so you can start on one floor and expand to the rest of the property.





Kettle & Trays

Description

The serving tray is made from high-quality wood with a high finish. A beautiful and useful item for home. The tray can be used for anything from serving coffee or tea, to finger foods at parties, cakes. the tray has a built-in drawer to keep your spoons or tea bag sugar pouches safely (accessories not included) this wooden tray can be used as a tray for breakfast in bed or as a serving tray. It provides 2 carry handles for a means of easy transport and cutlery, tea or sweet.



| Technical Details | |
|-------------------|---------------------------|
| Model | SCEK-101 |
| Capacity | 0.8L |
| Material | SS304 Stainless Steel |
| Power | Rate1000~1200W |
| Voltage | 220-240V, 50/60Hz |
| Controller | HULADE Controller |
| Ctn Size | 12pcs/ctn, 46.5X35.5X41cm |
| N.W/G.W | 10kgs/ 12.0kgs |
| Recommendations | 4-5 star hotels |
| Certificates | CE,CB(IEC),SASO,COC |

Hair Dryers

Description

Hair Dryer Wall Mounted comes from European classical design luxury and beauty, fashionable variety, high quality, safe and reliable. It is the first choice for a bathroom and a must of Star Hotel. The Wall Mounted Hang Up Dryer features 1200 Watts drying power and iconic technology for fast drying. Quiet, long-life motor. Popular with hotels and spas. The wall-mounted hair dryer design suitable for walls and drawers.



| Technical Details | |
|--------------------|-------------------------|
| Product Code | DPHD0001 |
| Product Name | Wall Mounted Hair Dryer |
| Material | ABS Plastic |
| Color | White |
| Power | 1200 W |
| Voltage | 220 V, 50 Hz |
| Air Speed | >11 m/s |
| Air Temperature | 65 ± 15°C |
| Current | 4.5A |
| Blowing rate | 12m/s |
| Blowing volume | 67m³/h |
| Water splash proof | IPX1 |
| Speed Setting | 2 |



Minibar

Description

- 1: Minibar is one of the products which are environmentally friendly, without fluorine, and cause no pollution to the atmosphere.
- 2: Minibar is without compressor, silent, and don't produce any noise, function stably, and soundly. The products can defrost automatically and belong to static-cooling refrigerators.



| Technical Details | |
|--------------------|---------------|
| Model | SCM-30 |
| Cooling Method | Absorption |
| Storage Temp. | 0-12 |
| Input Power(W) | 65 |
| Energy consumption | (kwh/24h)0.9 |
| Validity Capacity | (L)30 |
| Voltage(V) | AC220/110 |
| Type of controller | Digital |
| Type of Door Seal | Removable |
| Net/gross weight | (kg)16/18 |
| Shape size (WxDxH) | mm400x420x521 |
| Packing (WxDxH) | mm460*450*460 |

Telephone

Description

We are offering our clients a comprehensive range of Office Guest room Telephone. Designed and manufactured in adherence to the international standards using excellent quality components and the latest technology, this telephone is available in different designs and colors. The offered telephone is known for its features like fine finish, durability, and longer service life. Our valuable clients can avail this telephone from us at the most reasonable price.



| Technical Details | |
|-------------------|----------------------------|
| Model | SCTL-102 |
| One-touch Button | (+10,+5,+3,+0) |
| Music | Music on Hold |
| Function-1 | Automatic take-up function |
| Function-2 | Auto Re-dial |
| Ctn Size | 12pcs/ctn,46.5*35.5*44.5cm |
| N.W/G.W | 21.0kgs/ 22.0kgs |
| Recommendations | 4-5 star hotels |
| Certificates | CE,CB(IEC),SASO,COC |

Digital Safe Lockers

Description



The safe can be mounted onto the wall, shelf, or floor. It is constructed with steel, and the insides are properly carpeted. The steel construction is free from any scratches. The digital display offers three indicators for letting you know whether the safe is locked, unlocked, or out of battery. The shelves are adjustable, thereby providing a better degree of flexibility in storing medium or small-sized items.



| Technical Details | |
|---------------------|---------------------------------|
| Model | SCS-103 |
| 5 MM | Cold-Rolled Steel Door |
| Two 3/4 inch (19MM) | Diameter Steel Locking Bolts |
| Scratch- Resistant | Powder Coated Finish |
| Material | Cold-Rolled Steel |
| Size | L430mmxD370mmxH200mm |
| Working Voltage | DC6V or 4 AA Alkaline batteries |

Steam Iron

Description

Iron with the plastic body comes with an array of features to give you the best ironing experience. Light in weight, easy to use, and highly effective on creases, dry iron guarantees smooth performance every time. If you are looking for lightweight, quality dry iron for your daily ironing needs, look no further than the dry iron. The high quality non-stick sole plate makes sure that this iron glides easily and effortlessly on all types of fabrics. The C-type heating element further ensures uniform heat distribution. It consumes only .



| Technical Details | |
|-------------------|------------------|
| Model | SCIR-102 |
| Board Size | 91x30cm |
| Material | Metal |
| Board Color | Silver |
| Iron Model | SCI-102 |
| Maximum height | 85cm |
| Iron Size | 28.9x12.8x14.6cm |
| Diameter of Legs | 22/28/32mm |
| Water tank | Capacity 320ml |



Waste Bin

Description

Our bins are used for dry/wet waste of offices & homes. This feature is given, so as to avoid mosquitoes to enter and roam into it. It can be used with or without standard garbage bags.



| Technical Details | |
|-------------------|---------------------------|
| Model | 3220143 |
| Material | Metal |
| Finished | Powder coating & Polished |
| Color | Black & Polished |
| Dimension | X224X280Hmm |

Wooden Hangers

Description

Solid wood construction to hold your heaviest clothes Precisely cut notches on each end allow for hanging straps wooden coat hangers Precisely cut notches on each end allow for hanging straps.



| Technical Details | |
|-------------------|----------------------|
| Color | Wood |
| Material | Wooden |
| Finishing | Polished |
| Hook Type | Stainless Steel Hook |
| Packaging Type | Box |
| Minimum Order | Quantity 24 Piece |



Double-Side-Mirror

Description

Double-sided Mirror with 1X / 5X Magnification allows you to see small details. They offer the most versatility and are ideal for tasks like applying eyeliner or false eyelashes, even for tweezing and such. With adjustable wall-mounted, You can adjust the angle of the mirror and bring it closer to your face when necessary.



| Technical Details | |
|-------------------|---------------------------|
| Material | Stainless steel and brass |
| Size | 8 inch x 1 inch x 8 inch |
| Color | silver |
| Finish type | glossy mirror satin |
| Mount type | Wall-mounted |

Luggage Carts

Description

The compact cart features a strap, easy-grip handle, and flip-out support platform for larger luggage. Easy to carry foldable luggage trolley. Lightweight.

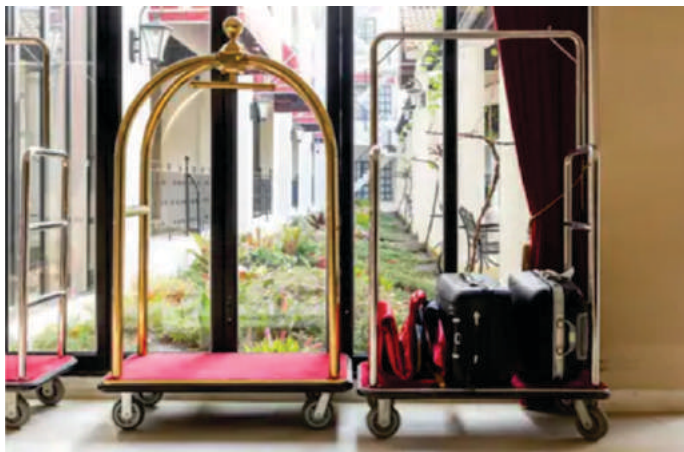

| Technical Details | |
|-------------------|--------------------------------|
| Specific Use | Hotel Trolley |
| Type | Hotel Furniture & Service Tool |
| Material | Metal, Stainless Steel |
| Size | L1100 x W650 x H1930mm |
| Color | Golden |



LED-Mirror

Description

3X Single Side Mirror: 3x Magnifying mirror, allow you to see clearly your facial features and make a perfect makeup in the dark or poorly light areas.
180-Degree Swivel Design: The mirror is adjustable, it tilts back fully for the most comfortable view. High-quality glass provides superior reflectivity and clarity.

LED Light: long working hours is not hot, soft light and perfect reflection. Best for use in home bathroom, luxury hotel and spa, Attractive and elegant design with high quality make by brass frame and crystal silvered glass.

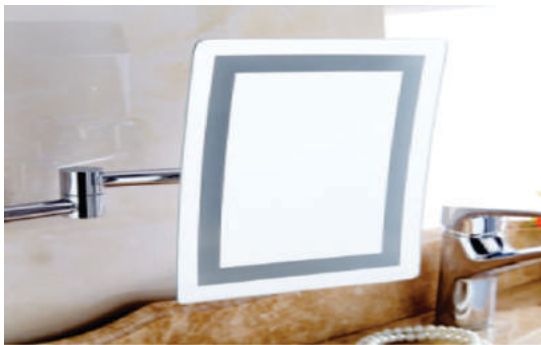

| Technical Details | |
|------------------------------|--------------------------------------|
| Rectangular Shape Frame less | LED Lighted Wall Mount Mirror |
| Frame Material | Brass |
| Stand material | 304 Stainless Steel |
| Size Mirror features | 6.5inch X 8.75inch Rectangular frame |

Automatic Hand Dryer

Description

Hydro Plus brings for your bathroom convenience, a smart automatic hand dryer. Constructed of ABS housing for enhanced durability, this product will make a great addition to your bathroom. It is a great alternative to hand towel dispensers as it is instrumental in saving paper. An automatic function facilitates an easy and smooth operation. It features two waves of hot and cold temperatures. With its ability to mount either in the corner or flat on a wall, it is a versatile piece.



| Technical Details | |
|--------------------|------------------------|
| Material | ABS |
| Power | 1800 W |
| Waves | Two Waves (Hot & Cold) |
| Voltage | 200 - 240 V , 50 Hz |
| Induction Distance | 5 mm - 20 mm |
| Air Speed | >20 m/s |
| Air Temperature | 65 ± 15°C |
| Current | 4A |
| Blowing rate | 20m/s |
| Blowing volume | 162m³/h |
| Motor speed | 3000 r/min |
| Water splash proof | IPX1 |
| Dry Hand Time | 15-18 Seconds |
| Dimension | 24 cm X 23 cm X 25 cm |



Stainless Steel Hand Dryer

Description

Bathroom convenience, a smart jet hand dryer. Constructed of stainless steel for enhanced durability, this product will make a great addition to your bathroom. It is a great alternative to hand towel dispensers as it is instrumental in saving paper. An automatic function facilitates an easy and smooth operation. The product offers quick airflow for speedy drying. With its ability to mount either in the corner or flat on a wall, it is a versatile piece.



| Technical Details | |
|-------------------|----------------------------------|
| Material | 304 Stainless Steel |
| Power | 1650 W |
| Voltage | AC220-240V / AC110-127V, 50/60Hz |
| Operation | Touch-Free Infra-Red Activation |
| Auto Cut Off | 30 Sec |
| Speed | 25000 RPM |
| Noise Level | 80db(A) |
| Heater Element | Heating PTC Element |
| Air Speed | 85-95 m/s |
| Drying Time | 5-7s |
| Motor | Brush Motor |
| Blowing Volume | 150 m3/h |
| Waterproof | IPX4 |
| Weight | 12 kg |

Tissue Paper Dispenser

Description

Hydro Plus brings for your bathroom convenience, a capacious and smart hand towel paper dispenser. Constructed of ABS housing for enhanced durability and featuring a standard design to fit all sizes of towel papers, this product will make a great addition to your bathroom. It facilitates an easy and smooth operation, and the unit is easy to refill. With its ability to mount either in the corner or flat on a wall, it is a versatile piece.



| Technical Details | |
|-------------------|-----------------|
| Capacity | 2 pkt |
| Operation | Manual |
| Paper Type | C Fold / M Fold |
| Material | ABS |
| Color | White |



Room Air Purifier

Description

Keep the air in your room fresh and the sound minimum so you can enjoy a good sleep all night, breathing clean air that is free of germs and allergens. This portable room air purifier is designed to give you a comfortable sleep all through the night. Air Purifiers are specially designed to bring clean & healthy air to all interiors. These improve the quality of air and keep dust, bacteria, viruses, pollen & allergies away. Sleek and smart in their looks, Air purifiers not only purify the air effectively with their unique 5 Step Purification system but also add style and glamour to the interiors.



| Technical Details | |
|-------------------|----------------------|
| Material | ABS & Metal |
| Color | White |
| SENSOR Type | Dust / Air Sensor |
| MOTER Type | AC motor |
| Power | 75W |
| Voltage | 220V-240V |
| Effective area | 40 sq m (430 sq ft) |
| CADR | 308m ³ /h |
| Weight | 6.3kgs |
| Max noise | 65dB |

Smart Hand Towel Paper Dispenser

Description

Hydro Plus brings for your bathroom convenience, a capacious and smart hand towel paper dispenser. Constructed of ABS housing for enhanced durability and featuring a standard design to fit all sizes of towel papers, this product will make a great addition to your bathroom. It facilitates an easy and smooth operation, and the unit is easy to refill. With its ability to mount either in the corner or flat on a wall, it is a versatile piece.



| Technical Details | |
|-------------------|--------------|
| Model No. | DPDR0023 |
| Operation | Manual |
| Material | ABS |
| Color | Black Color |
| Size | 255x130x66mm |



Shoe Shine Machine

Description

Automatic shoe polishing machine is operated by the infrared system. As you insert your shoes in the slot provided, the sensor gets activated and the soft brush present in it starts rotating automatically and removes the dust from the shoe, then you need to press the shoe towards the nozzle which contains the cream polish in a dispenser for black and brown colors separately. This process is completed in just 30 seconds and your shoes are well polished.

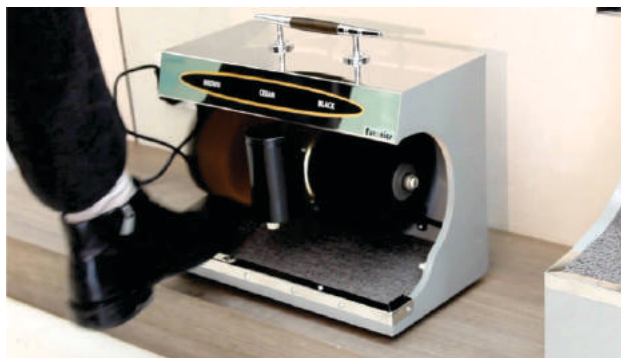

| Technical Details | |
|-------------------|-----------------------------------|
| Product | Shoe Shine Machine |
| Material | Wood / 304 Stainless Steel |
| Color | Silver, Operation Fully Automatic |
| Power | 90W , Rotational Speed 1,400rpm |
| Voltage | AC 220 V, 50Hz, |
| Cream Tank | Capacity 200 ml |
| TIME Protection | 15 Seconds |
| Used for | Brown shoes, black shoes |
| Dimension | 370 mm X 210 mm X 330 mm |
| Warranty | 1 Year Manufacturing Defect |

Housekeeping Trolley

Description

We are an eminent name, which is engaged in delivering House Keeping Trolley to honorable clients. The offered range of housekeeping trolley is made utilizing high-grade raw material and modern machinery in strict compliance with the international quality standards.



| Technical Details | |
|-------------------|------------------------------------|
| Stainless steel | construction with a brushed finish |
| Convenient | 3 shelves |
| 2 durable bags | With multi-functional pockets |
| 4 corner | Bumpers |
| 8" | solid wheels |
| 2 fixed castors | 2 swivel castors |
| Lockable lid | door |
| Loading capacity | up to 100kgs |
| Size | L1470 x W490 x H1230mm |



Magnetic Key Card

Description

A keycard lock is a lock operated by a keycard, a flat, rectangular plastic card with identical dimensions to that of a credit card or American and EU driver's license. The card stores a physical or digital pattern that the door mechanism accepts before disengaging the lock.



| Technical Details | |
|------------------------|------------------------------|
| Size | 3-3/8" x 2 1/8" (Standard) |
| Imprint Area | 3-3/8" x 2-1/8" (full bleed) |
| Type Safety | 1/8" all around |
| Card Stock | White 30 mil PVC |
| Printing | 4cp or spot PMS available |
| Magnetic Strip | 1/2" lo-coercivity (300oe) |
| Magnetic strip | Mid-range coercivity |
| (650oe) magnetic strip | high coercivity, (2750oe) |

RFID Key Card

Description

Our custom printed hotel key cards are a great way to make a lasting impression. These magnetic striped or RFID cards give you the ability to offer guests the appropriate level of access to your facilities all in one easy-to-use plastic key card that presents a customized marketing message. Plastic key cards are a great way to promote upcoming events and conventions, in-house dining or even create additional revenue by advertising local merchants.



| Technical Details | |
|-------------------|--------------------------------|
| Thickness | 0.84mm |
| Chip S50 | Ultralight, SRI 512, Icode etc |
| Size | 85.5mm x 54mm |
| Material | PVC Keycards |



Energy Saving Unit

Description

Keycard switches are designed to provide energy savings for the hospitality industry by ensuring that no devices are left on when the room is not in use. These switches control electrical circuits by simply inserting or removing the guest's access card into the device. Both line-voltage and low voltage switches are available for application.



| Technical Details | |
|-------------------|-----------------------|
| USE APPLICATION | WALL MOUNTED |
| COMPATIBLE WITH | ANY TYPE OF KEY CARDS |
| 30 to 40 Amp | CURRENT RATING |
| 25-30 | SECOND TIME DELAY |
| COLOUR | FINISH WHITE |

RFID Door Lock (E 4031)

Description

Hotel door Lock System

Our Hotel door lock system consist of, Set of Lock, Computer, Management software, Card Issuer (Encoder), Intelligent RFID cards, Energy saving switch.

Our system can integrate with other access system, such as Parking system, Lobby entrance, Elevator access, Swimming pool entrance, etc. Thus makes sure Guest are secured with access control using single card. This makes the Management to be more convenient to manage the Hotel.



| Technical Details |
|---|
| Model - SCL-101 |
| Induction operating frequency - 125 KHz or 13.56MHz |
| Applicable card - T5557, EM4305 Card ,M1 Card |
| Voltage - Four sections of 1.5V alkaline batteries |
| Alarm Voltage - < 4.8 V |
| Static power consumption - < 10 microamps |
| Dynamic power consumption - < 200 microamps |
| Temperature - 20 °C to 50 °C |
| Humidity - > 15.000 V |



RFID Door Lock (E 4032)

Description

Hotel Lock Management System

For all sizes of Hotels and Offices Electronic locks provide advanced security that cannot be found in regular turn-key locks. The electronic style hotel lock has become a standard issue in the accommodation industry. There are many different benefits that come with using a hotel lock system such as.

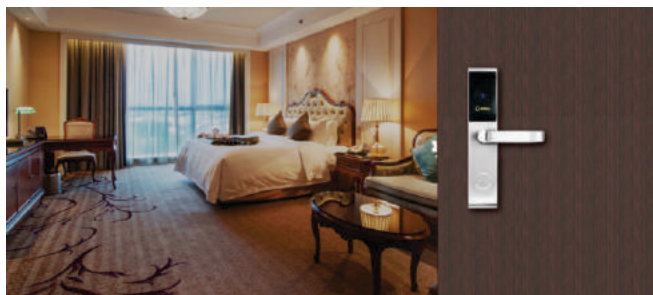

| Technical Details |
|---|
| - 304 Stainless Steel panel and handles |
| - 5 latches ANSI U.S. standard mortise |
| - Override mechanical key |
| - 4 pc AA Cell, a minimum of 12 months lifespan |
| - Low Voltage warning |
| - Mifare Technology |
| - Classified Access Authorization |
| - General Master, Building master, Emergency card, House Keeping card |
| - Lost card suspension |
| - Common door functions like Swimming pool, Gym, fitness center. |
| - Meeting room function |
| - 210 pcs opening records |
| - Step by step user-friendly software |
| - Software operation records |
| - Classified operating authorization |
| - Download the lock opening records |
| - Support Winxp, win7, win8, vista |
| - Support 32/64 digit system |
| - Interface with major PMS. |
| - Suspend lost card, blacklist certain users. |

RFID Door Lock (E 4033)

Description

Hotel Lock Management System

RFID Door Lock- Electronic Hotel Lock System are a new and improved way of being able to access a room or home without having to use a bulky key, this kind of lock is opened with a PVC Smart Card or RFID Access Card, simple and light just like a credit card. Electronic Lock which designed especially for hotels & Resorts brings a new user experience to guests and hotel owners. Guests now could just hold a card when they are out of the room which makes it easier than carrying a key. No Matter how many rooms he needs to enter, all will be just a card.



| Technical Details |
|--|
| - 304 Stainless Steel panel and handles |
| - 5 latches ANSI U.S. standard mortise |
| - Override mechanical key |
| - 4 pc AA Alkaline Battery, minimum 12 months lifespan. |
| - Low Voltage warning. |
| - Mifare Technology |
| - Classified Access Authorization |
| - General Master, Building master, Emergency card, House Keeping card... |
| - Lost card suspension. |
| - Common door functions like Swimming pool, Gym, fitness center. |
| - Meeting room function |
| - 240 pcs opening records |
| - Step by step user-friendly software |
| - Software operation records. |
| - Classified operating authorization. |
| - Download the lock opening records. |
| - Support Winxp, win7, win8, vista. |
| - Support 32/64 digit system. |
| - Interface with major PMS. |
| - Suspend lost card, blacklist certain users. |





Room Door Bell

Description

Hotel Doorbell System Touch Panel with Room Number in Plastic Outline Frame Touch operation Once visitors touch the surface of the Outdoor panel, the doorbell chime will ring. If hotel guests do not want any disturb, he/she just touch the icon in Indoor panel. Then an indicator on outdoor panel will show to tell others DO NOT DISTURB. It is the same case for MAKE UP button of touch panel.

- (1) WEAK Electricity touch type
- (2) Do not disturb and make up room function.
- (3) Room number indicator
- (4) LED back-light indicator



| Technical Details | |
|-----------------------|--------------------------------|
| Panel Material | Acrylic / Tempered Glass |
| Operating Temperature | 15 C ~ 60 C |
| Voltage | A/C 220V |
| Power Consumption | (24h)< 1W |
| Service LifeTouch | Unlimited Use |
| Relay Contacts | 100,000 Times |
| Bottom Box | Installation86*86mm Bottom Box |

Room Door Bell

Description

Hotel Doorbell System Touch Panel with Room Number in Plastic Outline Frame Touch operation Once visitors touch the surface of the Outdoor panel, the doorbell chime will ring. If hotel guests do not want any disturb, he/she just touch the icon in Indoor panel. Then an indicator on outdoor panel will show to tell others DO NOT DISTURB. It is the same case for MAKE UP button of touch panel.

- (1) WEAK Electricity touch type
- (2) Do not disturb and make up room function.
- (3) Room number indicator
- (4) LED back-light indicator attendants can clearly aware of the request to need to be cleaned up.



| Technical Details | |
|-------------------------|--------------------------|
| Panel Material | Acrylic / Tempered Glass |
| Operating Temperature | 15 C ~ 60 C |
| Voltage | A/C 220V |
| Power Consumption | (24h)< 1W |
| Service LifeTouch | Unlimited Use |
| Relay Contacts | 100,000 Times |
| Bottom Box Installation | 86*86mm Bottom Box |





Handicap Grab Bar

Description

Wall mounted ABS and Stainless Steel Handicap Grab Bar is designed to foldable, perfect to use in the limited spaces like in the bathroom. White color is suitable for almost the every decoration style. Easy to install on the bathroom walls with the heavy duty mount plate, provide superior supports and protections to your family, special for old parents, pregnant woman and those unable to move freely. Designed specifically with safe structure and maximize usability. You can fix this hand rail nearby washbasin, toilet, bathtub, shower room to help you get up and sit down.

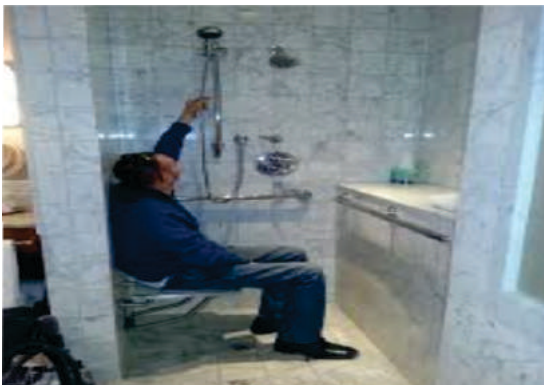

| Technical Details | |
|--------------------|-------------------------------|
| Model No. | DHGB0002 |
| Swing | Wall Mount |
| Material | SS Tube Coated With 5mm Nylon |
| Operation Moveable | (Horizontally & Vertically) |
| Color | White |
| Size | 605mm |
| Capacity | 200 Kg |

Cloths Line

Description

Stainless Steel Retractable Clothesline is a compact device to aid you in hanging your laundry to dry. It features a retractable clothesline having a maximum length of 8 feet. The adjustable and retractable clothesline can retract automatically. It can hold a weight of approximately 5kgs. The line easily retracts back to its case for easy storage.



| Technical Details | |
|-------------------|-----------------------------|
| Material | 304 Stainless Steel & Brass |
| Operation | Retractable |
| Shape | Round |
| Color | Gold |
| Capacity | 6 to 7 Kg |
| Rope Size | Rope Opens up to 8ft |
| Dimension | 10cmx10cmx6cm |

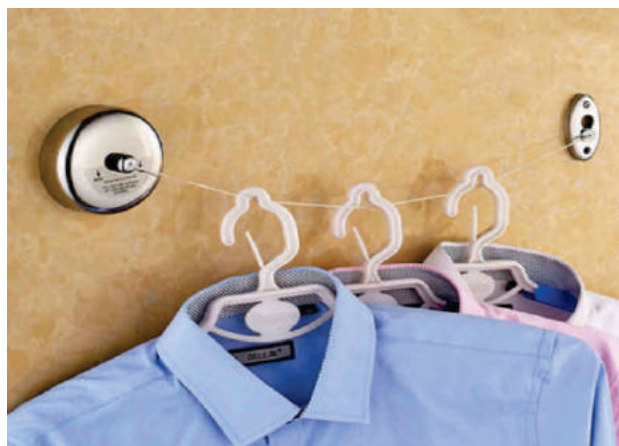



Automatic Faucet

Description

Automatic Brass Sensor Tap is a chrome sink tap made of quality solid brass which is great for home and commercial use. Equipped with a sensor, the tap automatically supplies water as soon as hands are within sensing range and stops when you move away your hands. This efficient tap is designed for a smooth operation and a drip-free experience.



Technical Details

| | |
|------------------|--|
| Model No. | DAST0008 |
| Color | Silver |
| Mount Type | Basin Mount |
| Sensor Type | Infra-Red Sensor |
| Water Output | 1.5 L - 2.0L / Minute |
| Sensing Range | 10-20 cm |
| Dual Operation | Solar + Battery |
| Battery Operated | 4 x AA Duracell Battery (not included) |

Stainless Steel Hand Dryer

Description

Touch less to prevent the spread of bacteria and the cross infection of the disease; Using infrared sensor, chip control technology, superior and stable performance; Strong wind, safe time, rapidly dry hands within 10 seconds; Stainless steel design, beautiful and easy, strong and durable; Multiple protection for over-temperature and timeout, use more secure; Low noise, health, safety and energy saving; Touch less to prevent the spread of bacteria and the cross infection of the disease; Ideal used in hotels, office buildings, restaurants, shopping malls, food factory, hospital, stadium, other public places and every family, etc.



| Technical Details | |
|-------------------|---------------------------------|
| Material | 304 Stainless Steel |
| Power | 1350W |
| Voltage | AC220-240V / 110-127V, 50/60Hz |
| Operation | Touch-Free Infra-Red Activation |
| Auto Cut Off | 60 Sec |
| Speed | 25000 RPM |
| Air Speed | 95 m/s |
| Drying Time | <15 s |
| Motor | Brush Motor |
| Waterproof | IPX1 |
| Product Size | 255x150x175 mm |
| Waves | Hot & Cold Waves |





Foam Soap Dispenser

Description

We offer our clients high quality 1000 ml ABS Plastic Soap Dispenser that is widely used in hotels, malls, hospitals, various institutions and industries for hygienic hand wash. Our 1000 ml soap dispenser is designed for extremely heavy duty use and its pump is tested for 300000 pushes.



| Technical Details | |
|-------------------|-------------------------------|
| Capacity | 1000 ml |
| Operation | manual |
| Material | ABS |
| Color | White |
| Dispense | Volume 1-1.5 ml per one press |
| Suitable For | Foam Dispenser |

Baby Diaper Changing Stations

Description

Baby Protection Safety Seat combines exceptional health, safety, and convenience features. Changing station is manufactured with an antimicrobial agent that inhibits the growth of odor and stain-causing bacteria and helps reduce the risk of cross-contamination. For your convenience, the bed features an ergonomic design for one-handed opening and closing as well as two built-in hooks to provide ready access to a diaper bag or purse. A safe, clean, easy to use baby changing station that both baby and parent will enjoy.



| Technical Details | |
|-------------------|----------------------------------|
| Mount Type | Wall Mounted |
| Material | HDPE (High Density Polyethylene) |
| Maximum | Load 25 kgs |
| Dimensions | 855(w) x 560(H)mm |
| Depth | Closed 107 mm |
| Extension | Open 495 mm |





Hotel Hospitality



Sewage-Pumps



Swimming Pools



Designer Fountain



Infrared Sauna



Multi System



Chiller Bath



Bath Tub with Jacuzzi



Steam Bath

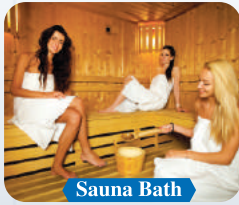

Sauna Bath



Bath Cabin



Spa Bath



Hydro Plus Industries Pvt. Ltd.

e - mail: info@hydroplus.co.in,
hydroplusindustries@gmail.com

Website: www.hydroplus.co.in

Customer Care No.: 9540650069



Now Join Us On

 Twitter:- <https://twitter.com/hydroplusinds>

 You tube:- <https://www.youtube.com/channel/UCHMoo11het29kT-SxVVAdbw>

 <https://www.linkedin.com/company/hydro-plus-industries/>

 Facebook:- <https://www.facebook.com/hydroplusindustries/>

Authorized Dealer:

